

Single Crystal Diffraction: The Definitive Structural Technique

Christine M. Beavers

21st National School on Neutron & X-ray Scattering

June 17th, 2019





crys·tal·log·ra·phy

the branch of science dealing with the formation and properties of crystals

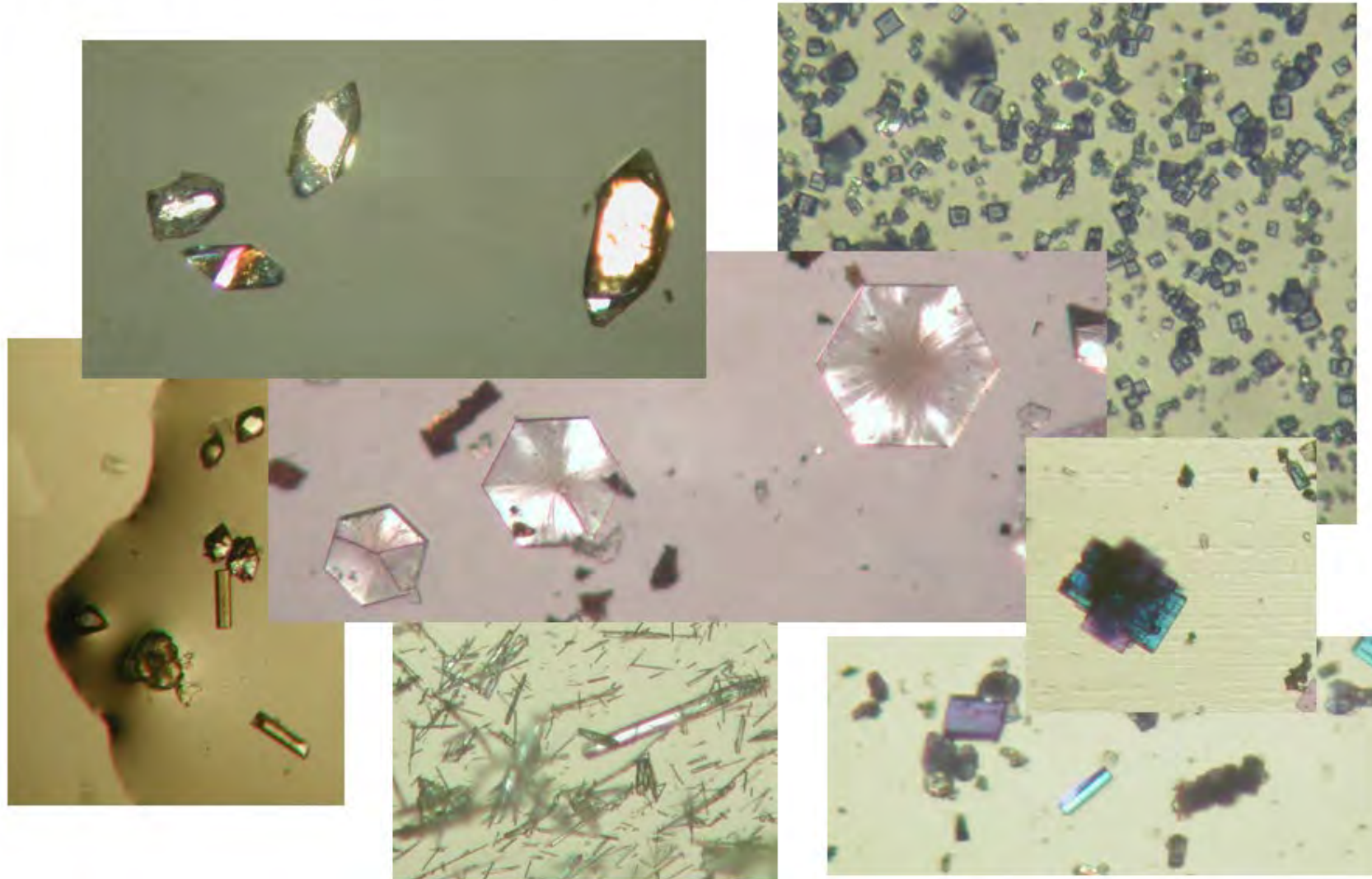

What is a Crystal?



- A crystal is a periodic arrangement of matter

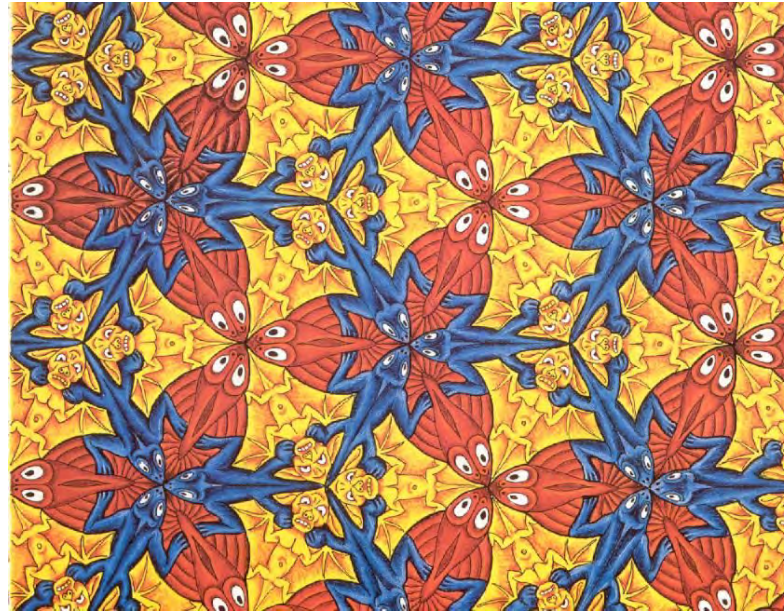

Search Escher tessellations for more

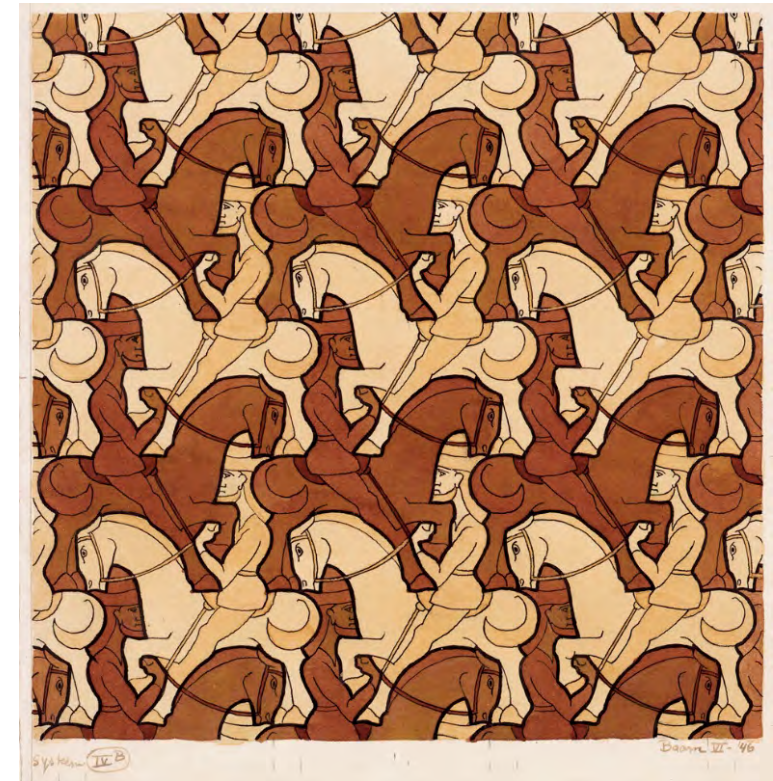



What is a Crystal?



- A Crystal is a three-dimensional repeating array of atoms or molecules.
- In this example, our molecule is going to be in a shoebox, for simplicity.

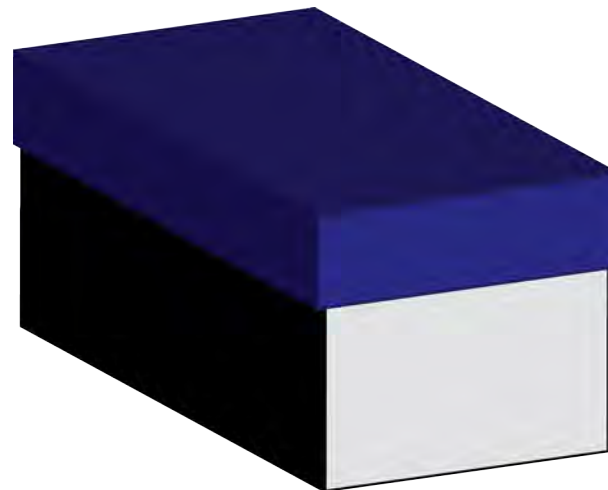

Dimensionality

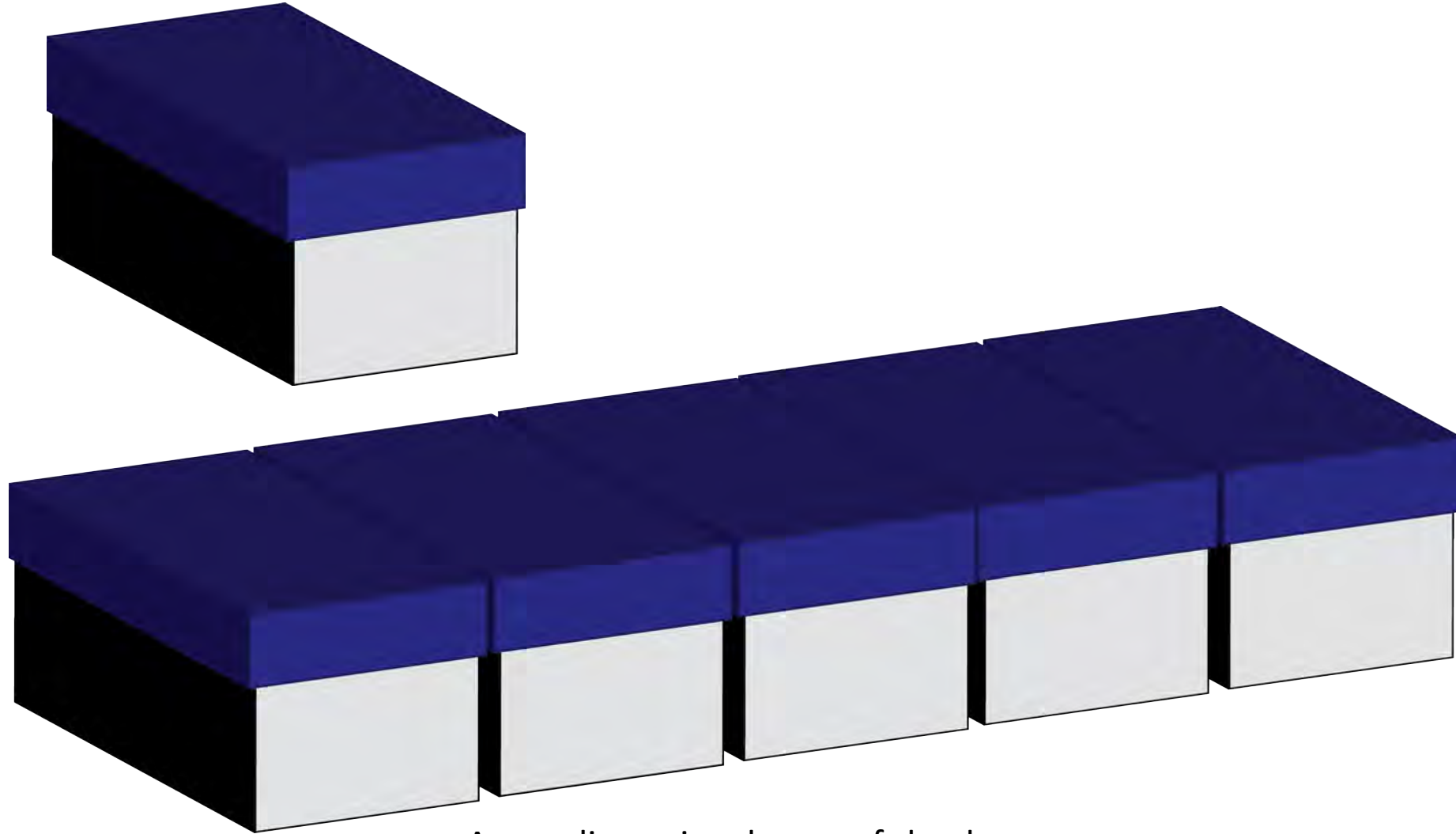

A one-dimensional array of shoeboxes

Dimensionality

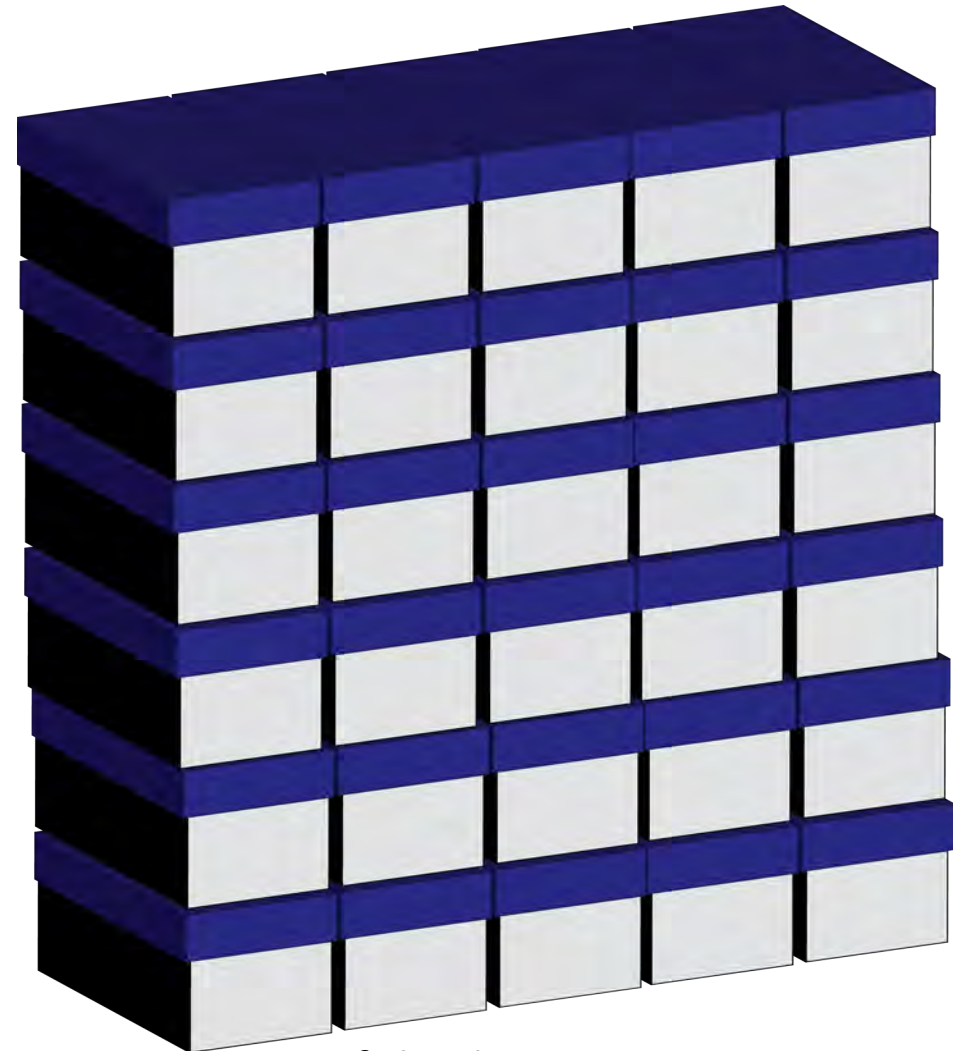
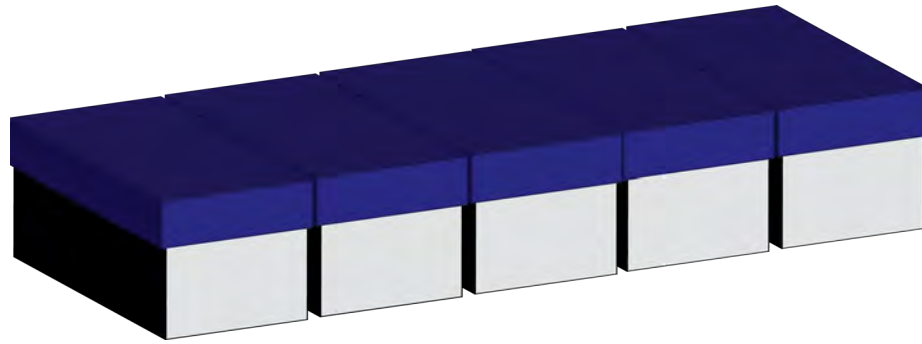

A two-dimensional array of shoeboxes

Dimensionality

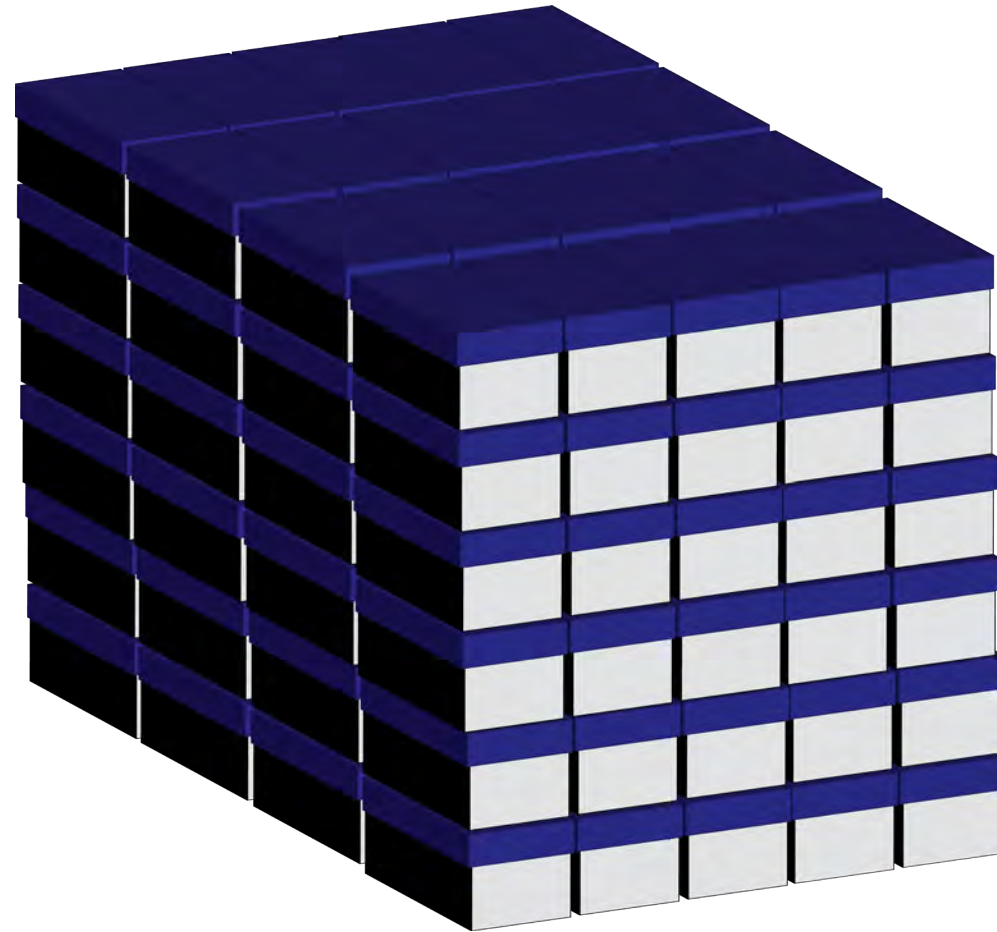
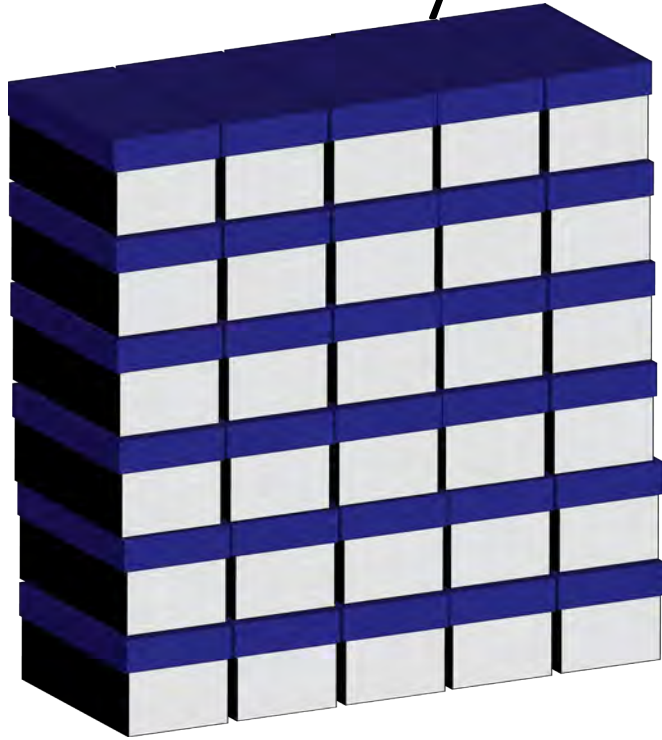

A three-dimensional array of shoeboxes

From Shoeboxes to Unit Cells



Unit Cell Definition:

Smallest volume unit of highest symmetry which, when translated in 3D will generate the crystal

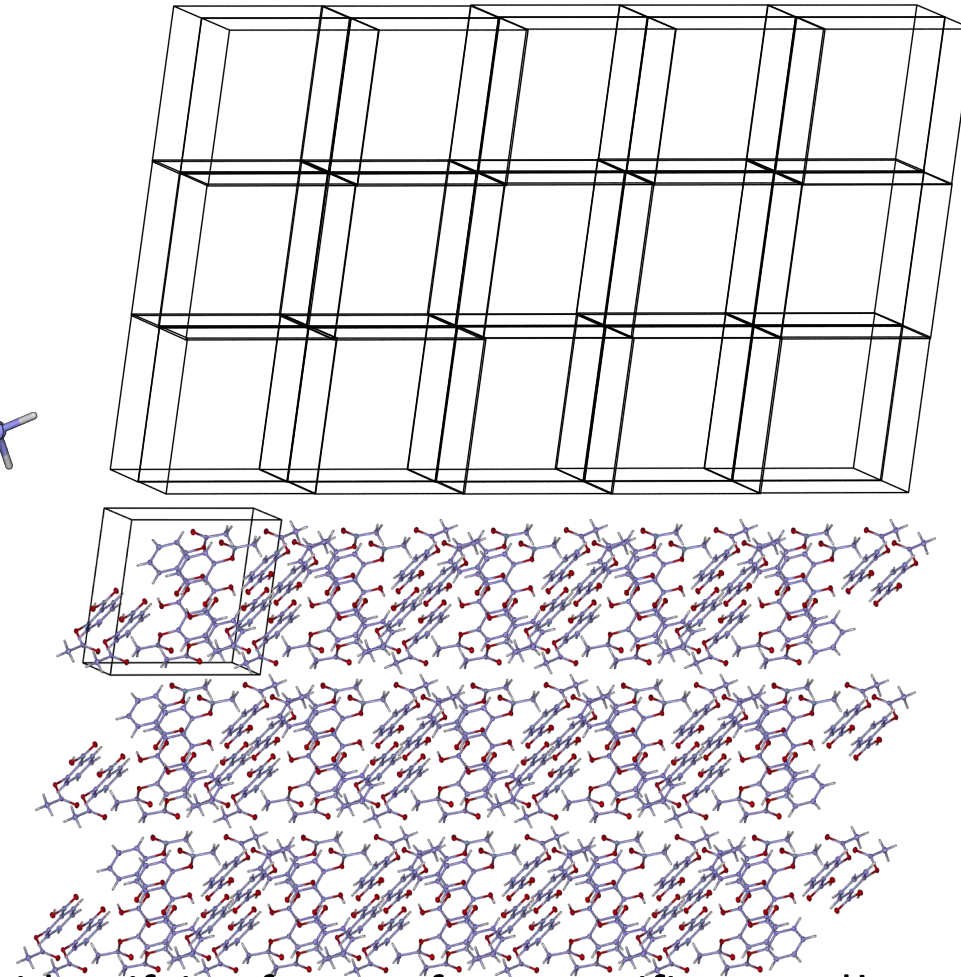
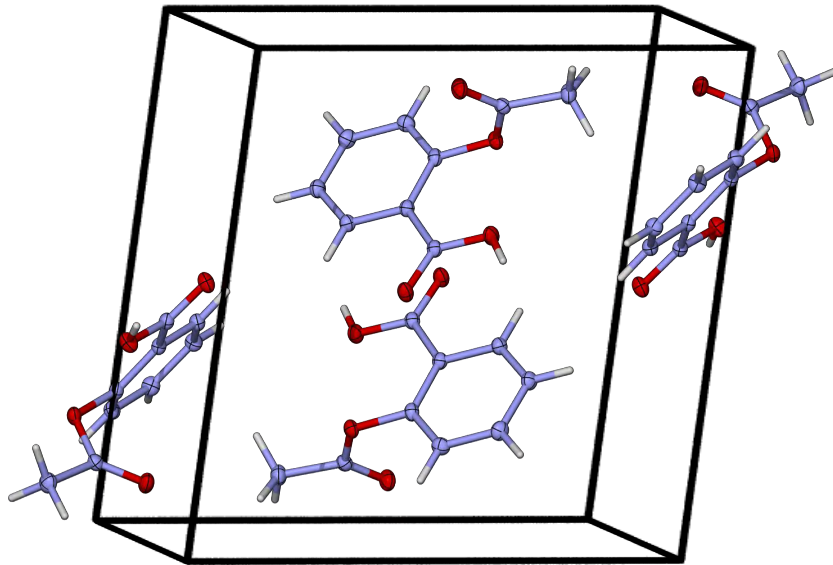

The dimensions of the Unit Cell are an identifying feature for a specific crystal!

Crystal to Structure

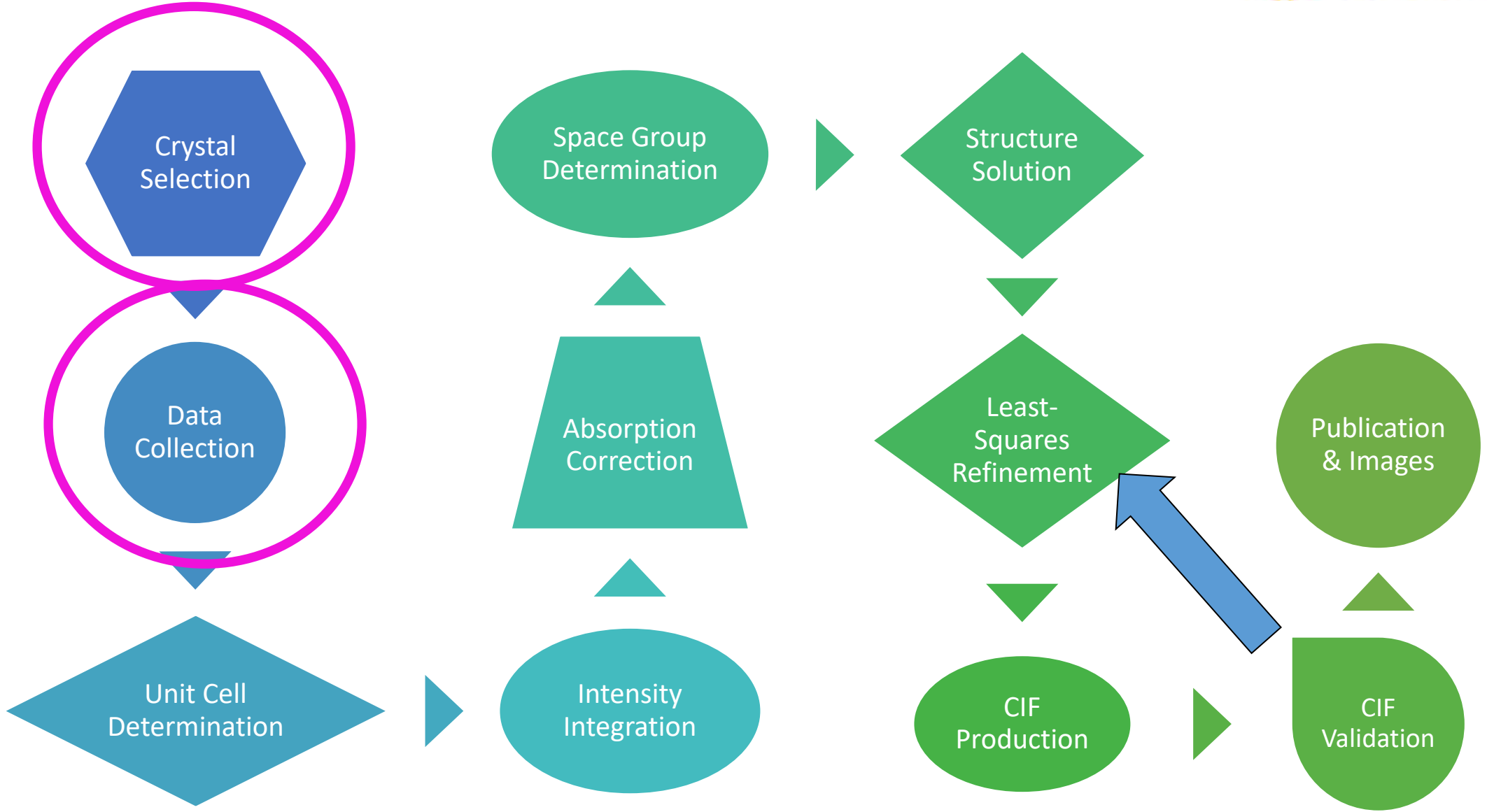



Crystal Selection #LifeGoals

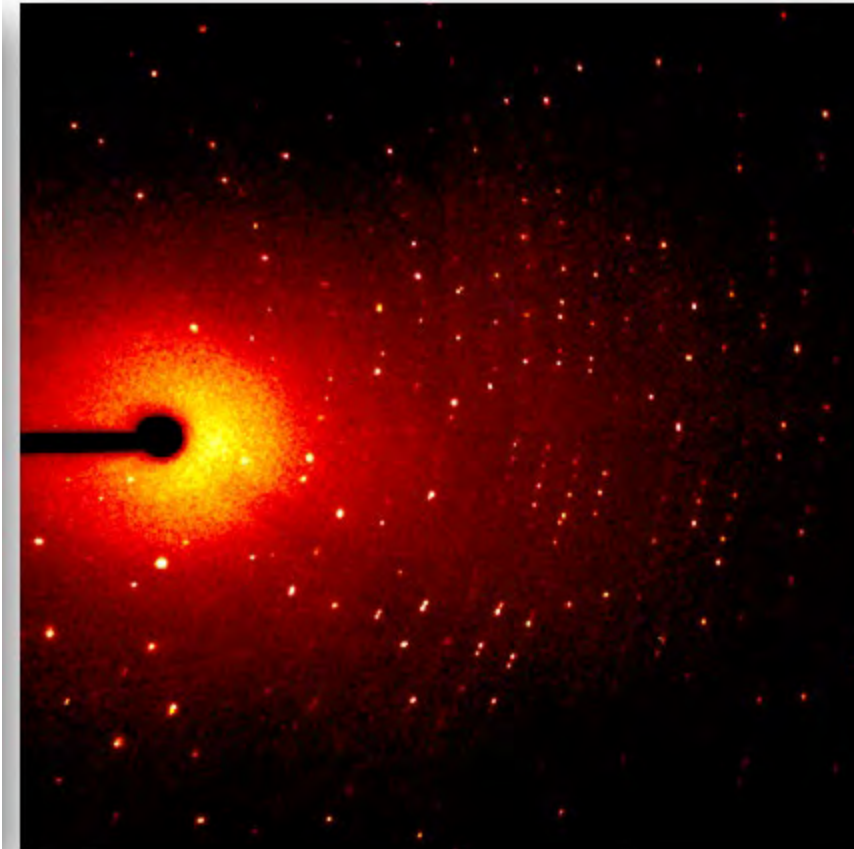
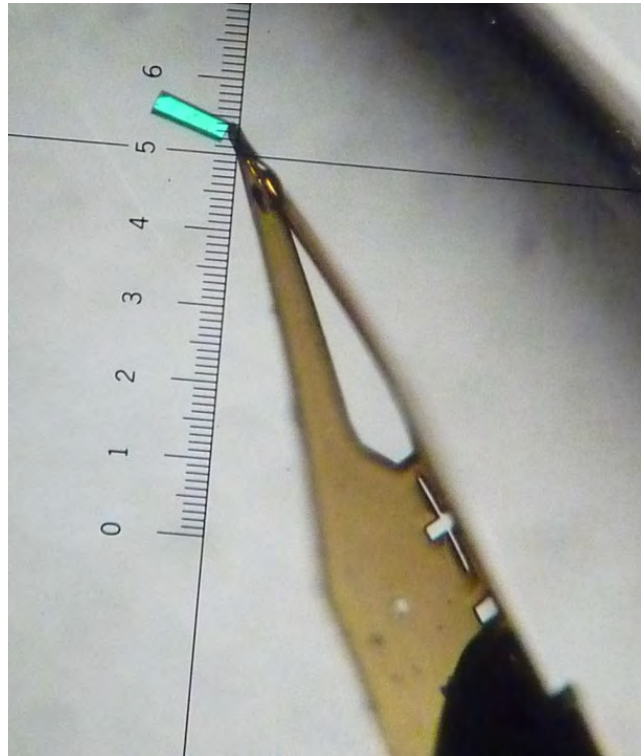

Nice crystals are more likely to have nice diffraction



Diffractometer Schematic

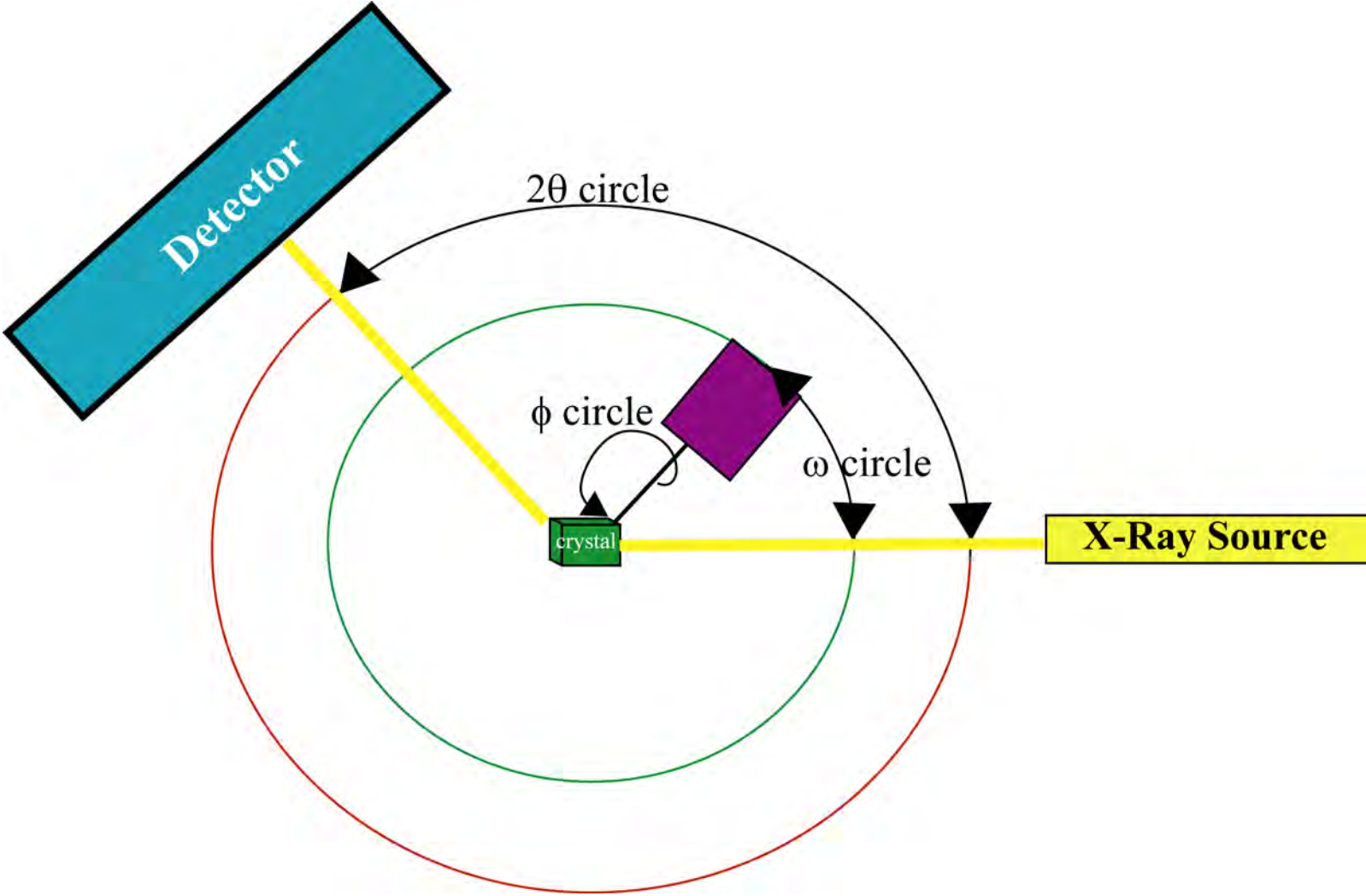



SXD Diffractometer

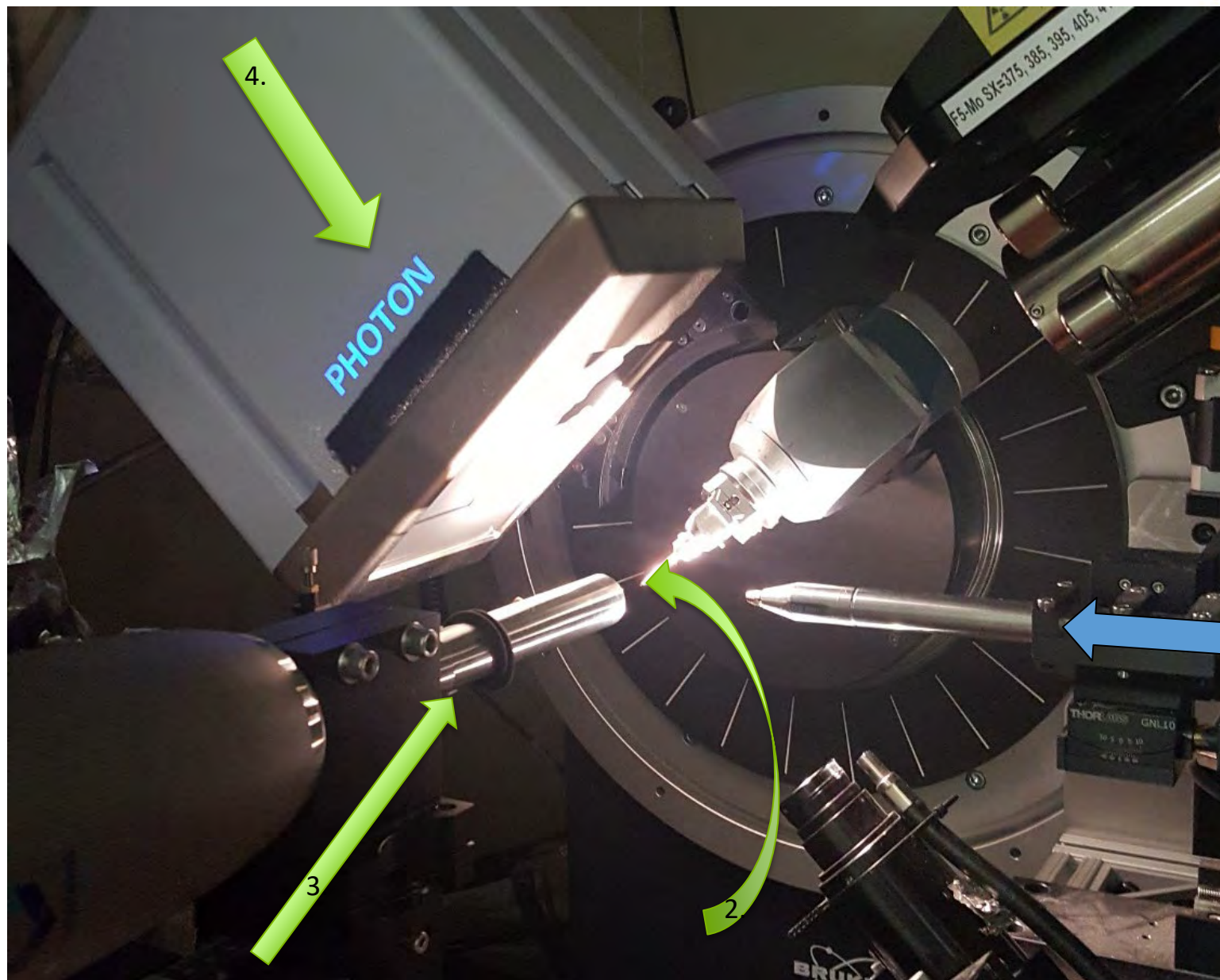



Data Collection Schematic

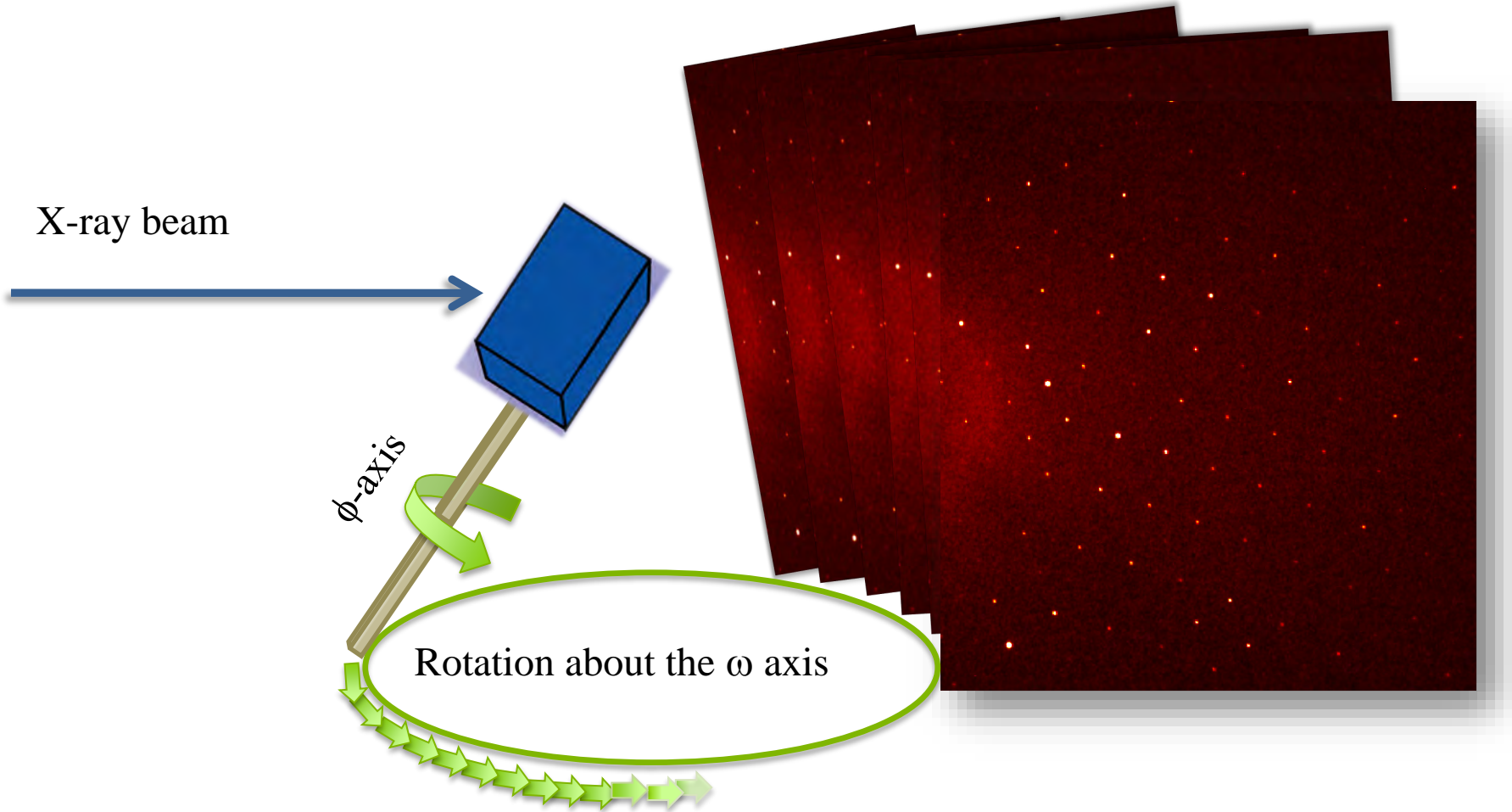



Data Collection



Crystal to Structure

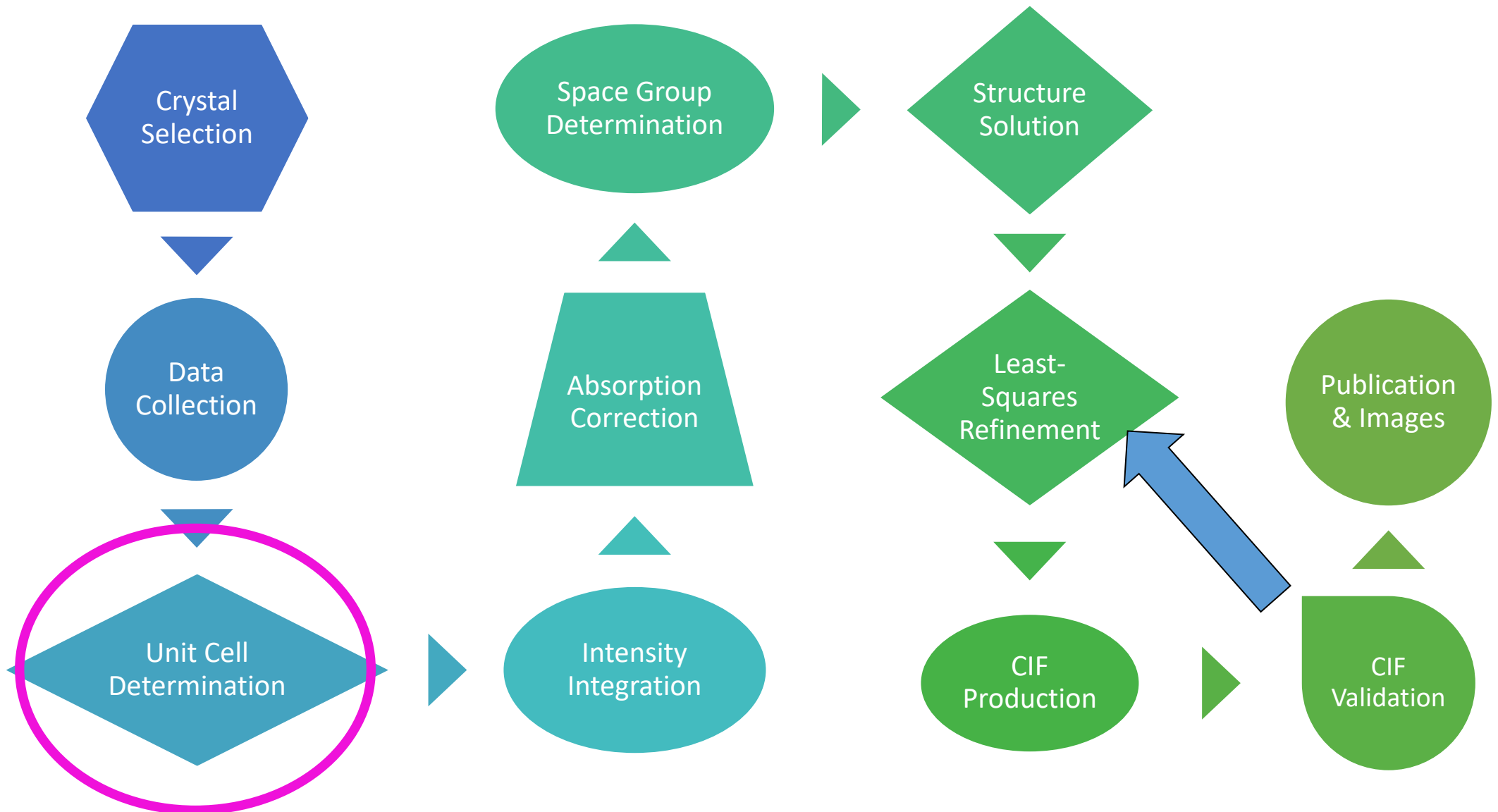



Indexing

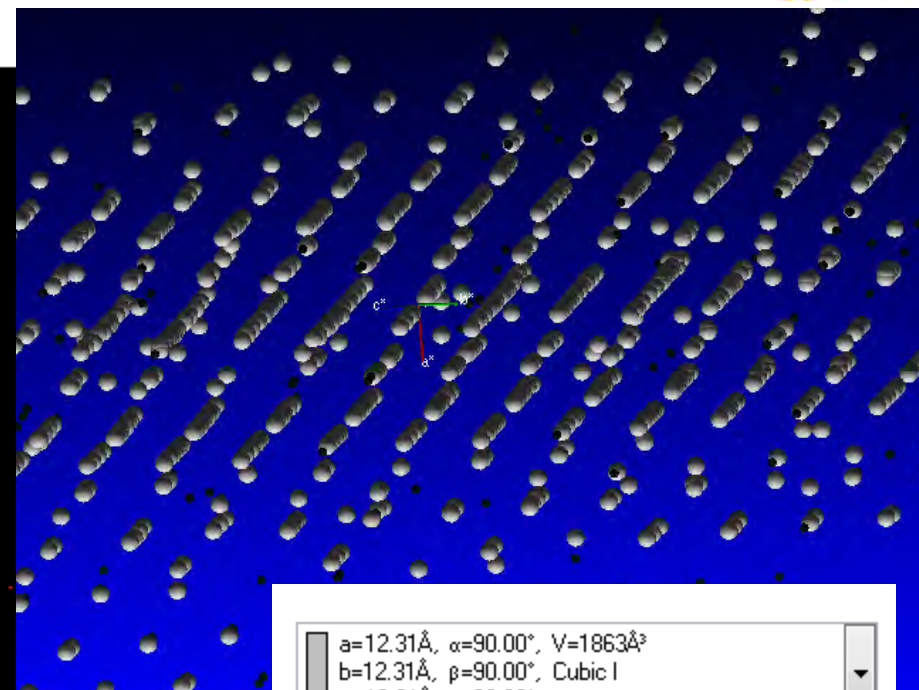
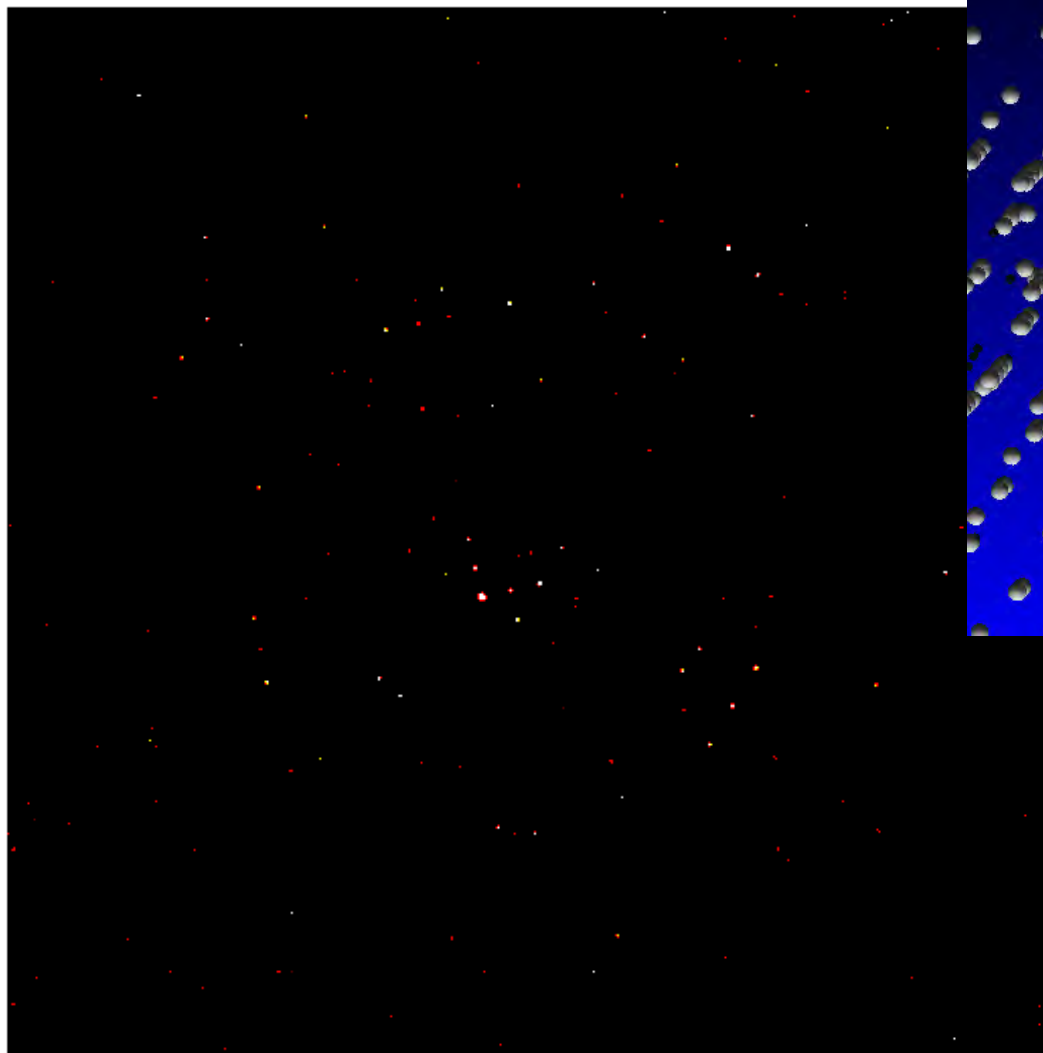

a=12.31Å, $\alpha=90.00^\circ$, V=1863Å³
b=12.31Å, $\beta=90.00^\circ$, Cubic I
c=12.31Å, $\gamma=90.00^\circ$

<input checked="" type="checkbox"/> Unit cell	
a [Å]	12.3052 ± 0.0008
b [Å]	12.3052
c [Å]	12.3052
α [°]	90.00
β [°]	90.00
γ [°]	90.00
V [Å ³]	1863.2 ± 0.4
<input type="checkbox"/> Domain translation	
x [mm]	0.04
y [mm]	-0.02

Crystal to Structure

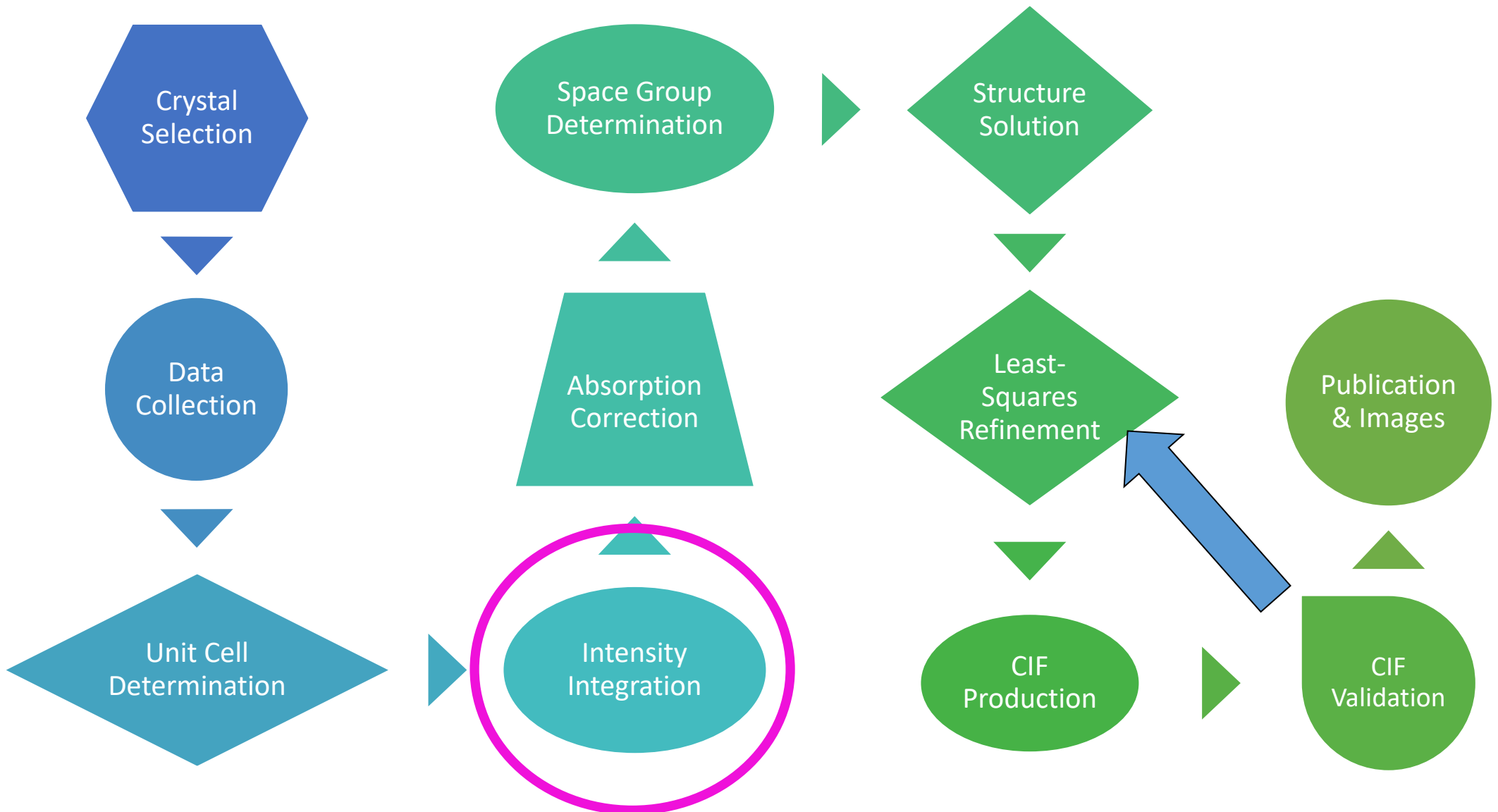



Data Integration

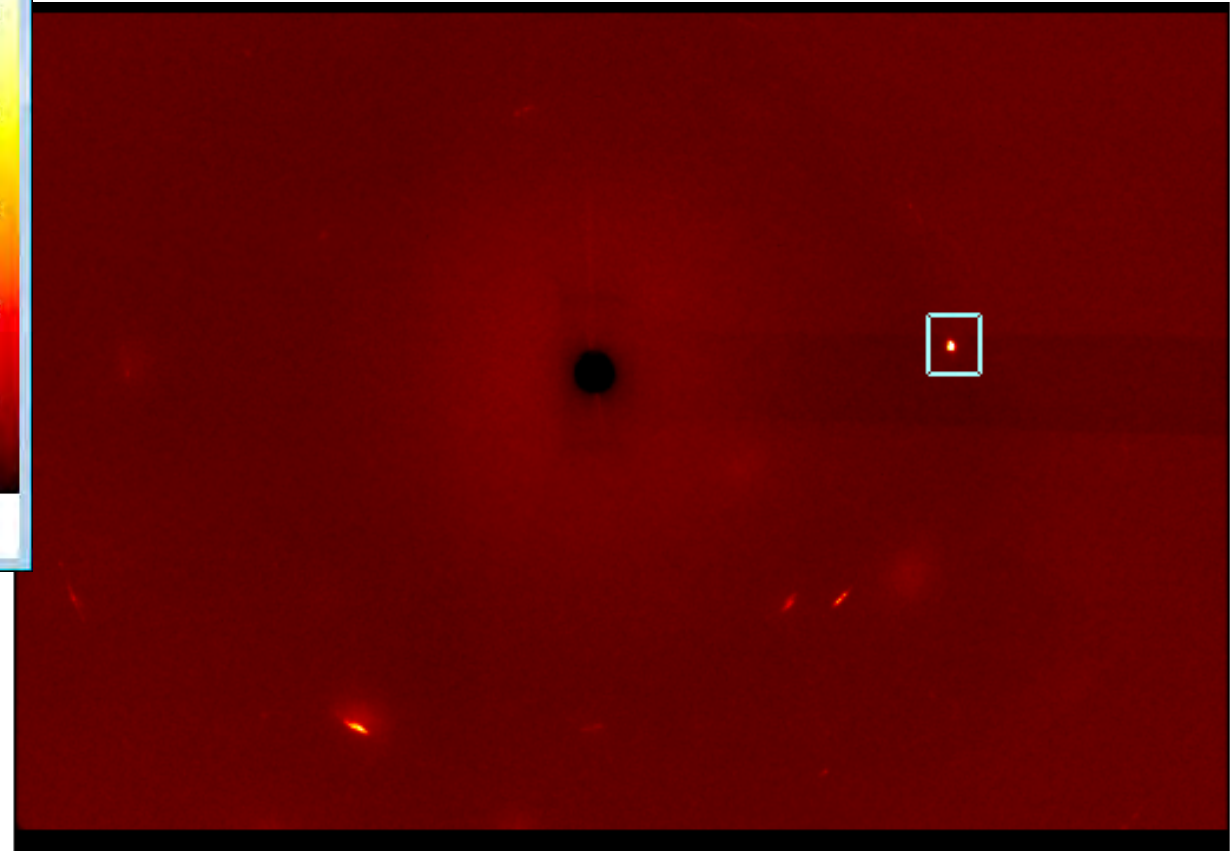
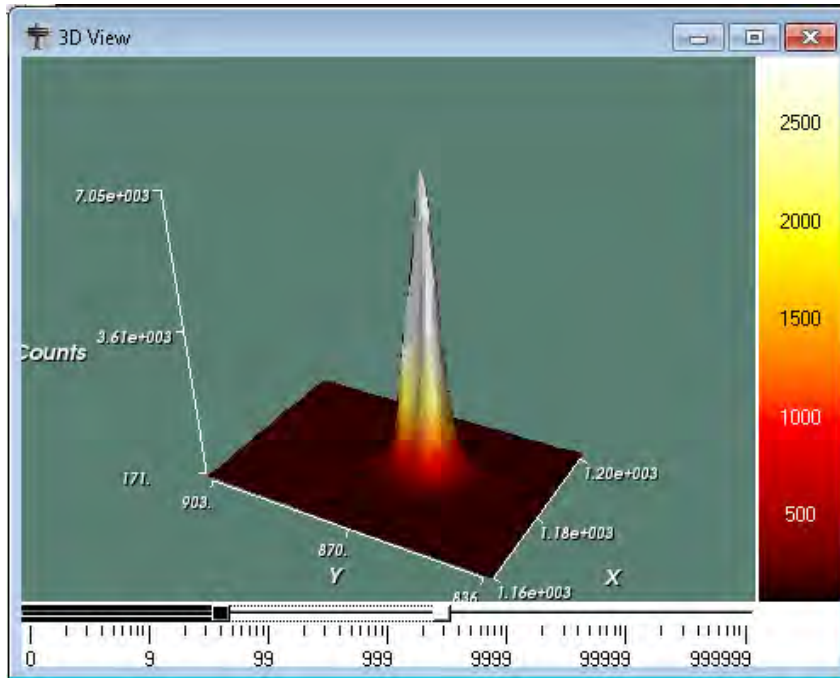

Crystal to Structure

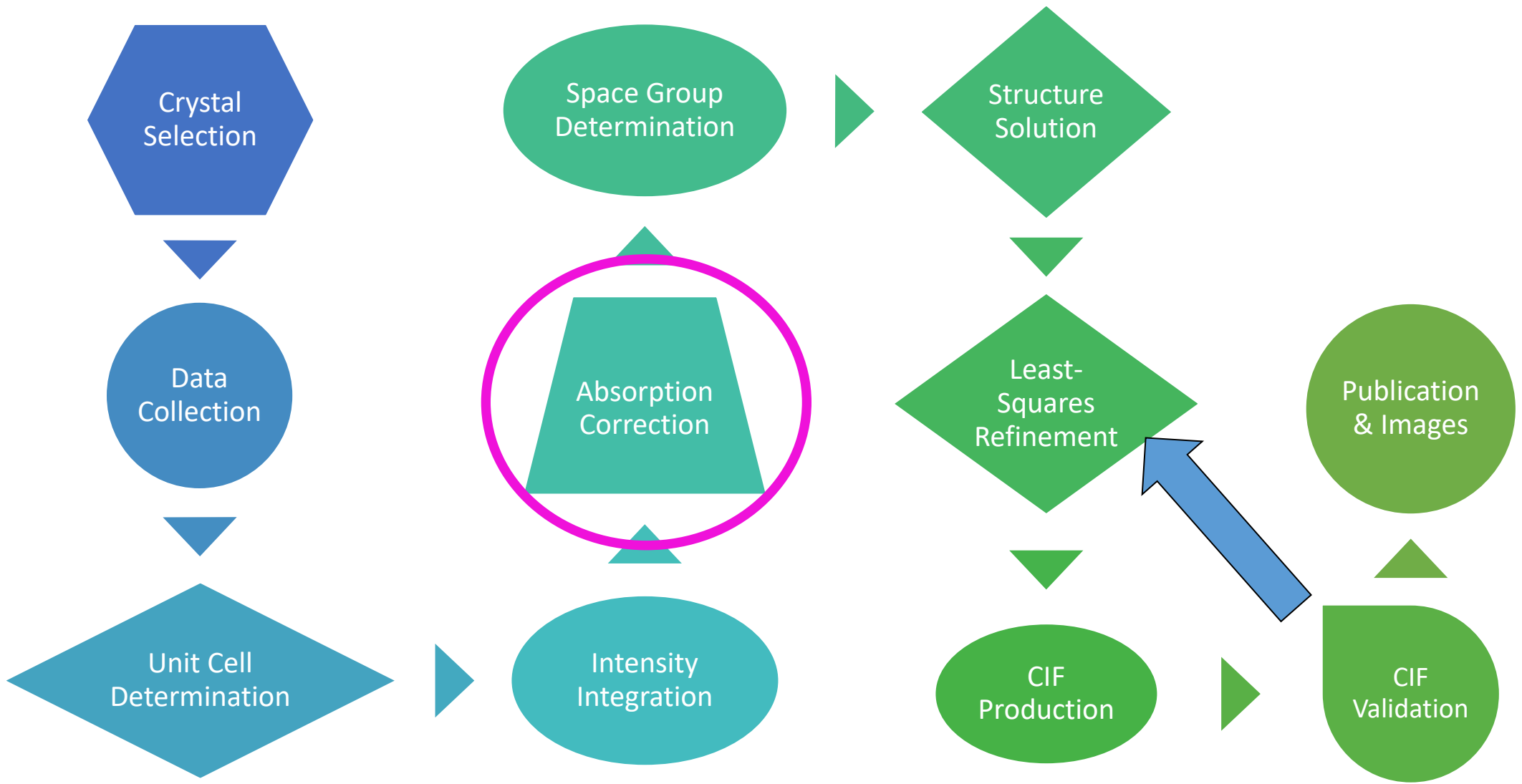



Absorption Correction



Overall scale and R(int) variations for Test

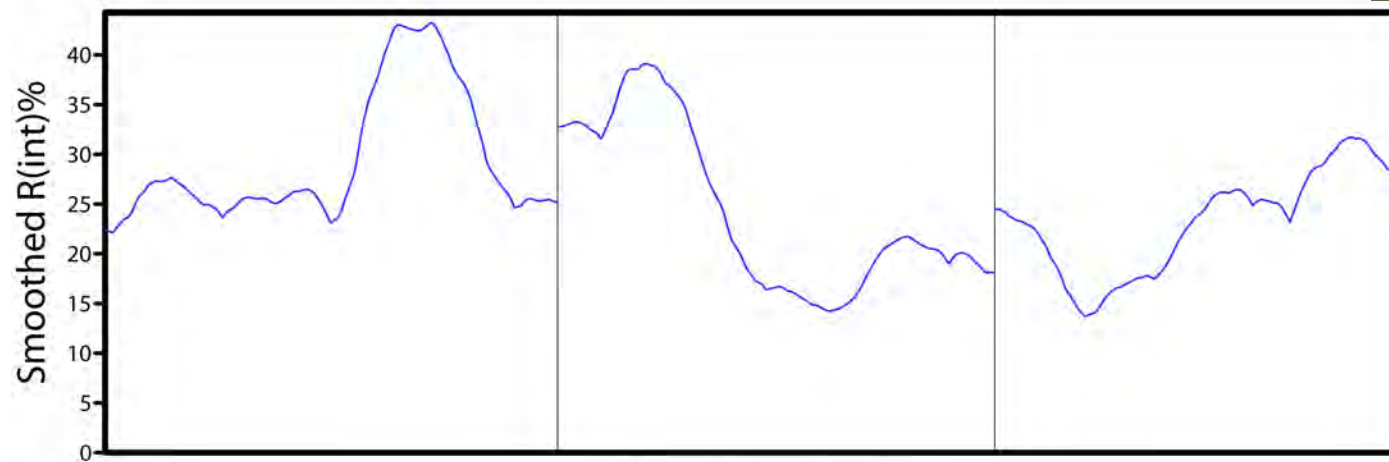
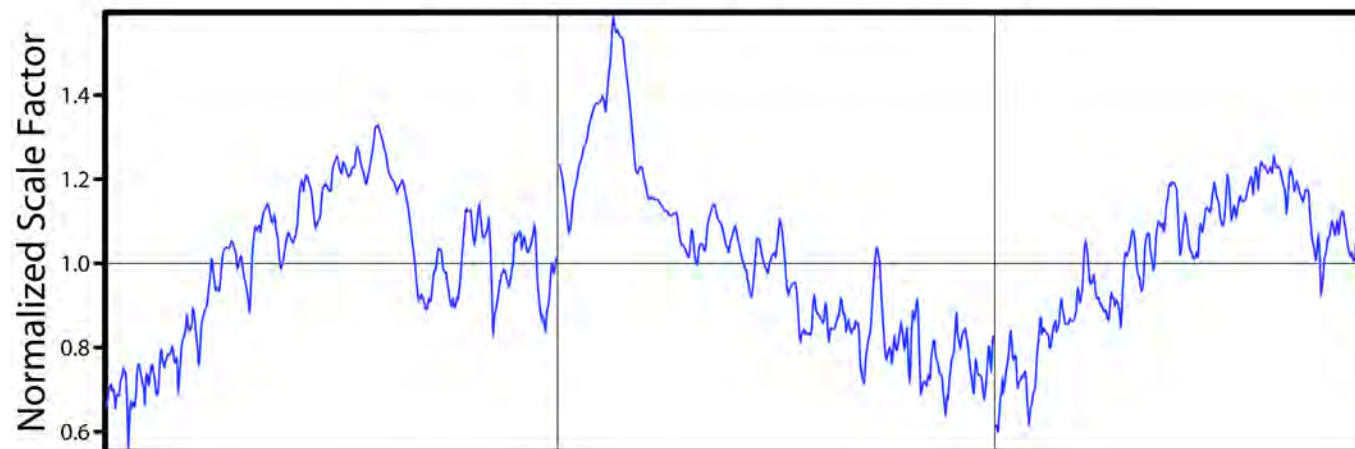

Run/Frame -->

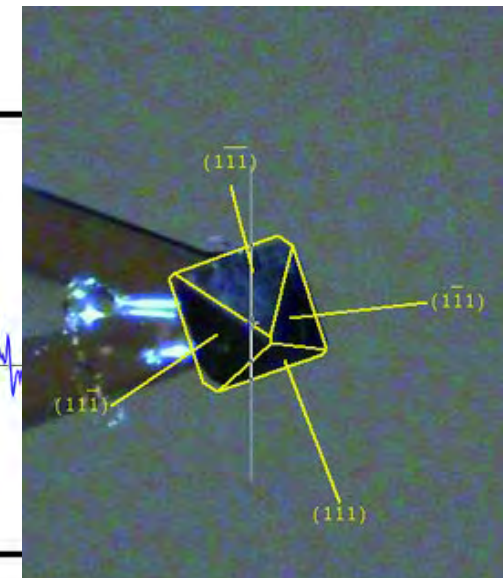

Crystal to Structure

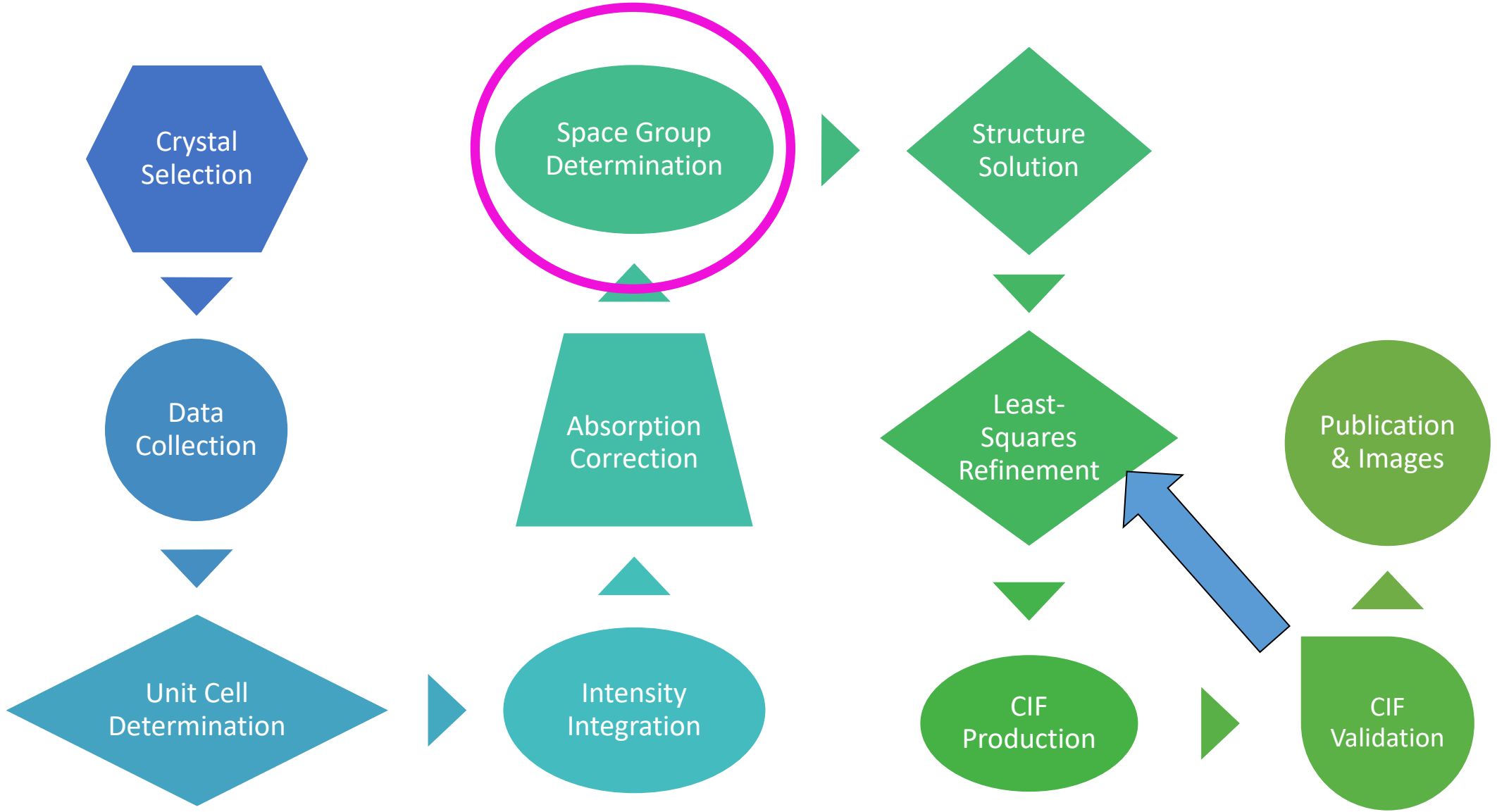



Why do I need a space group?

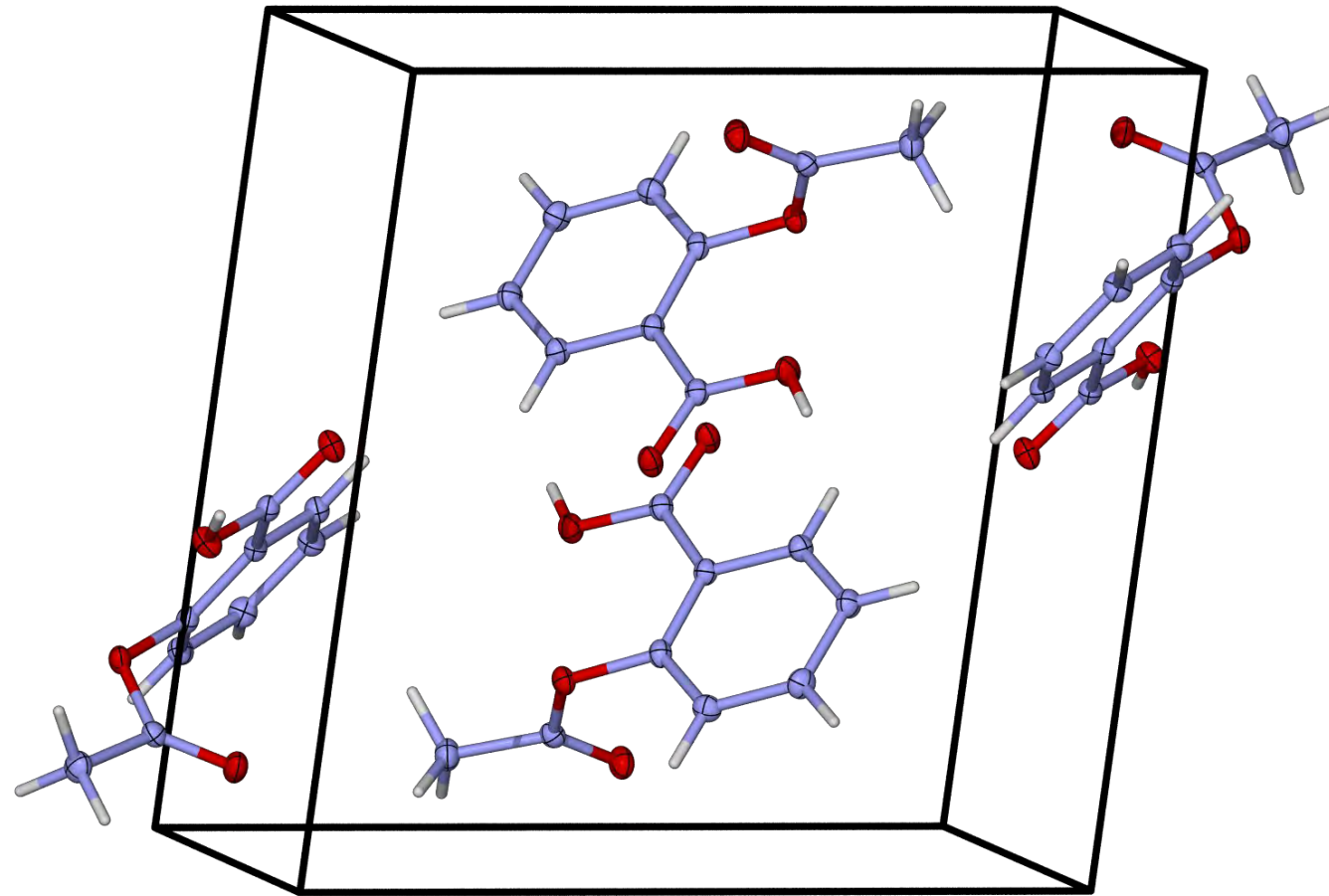

Escherer loved his symmetry



- Tessellations are made using symmetry operations

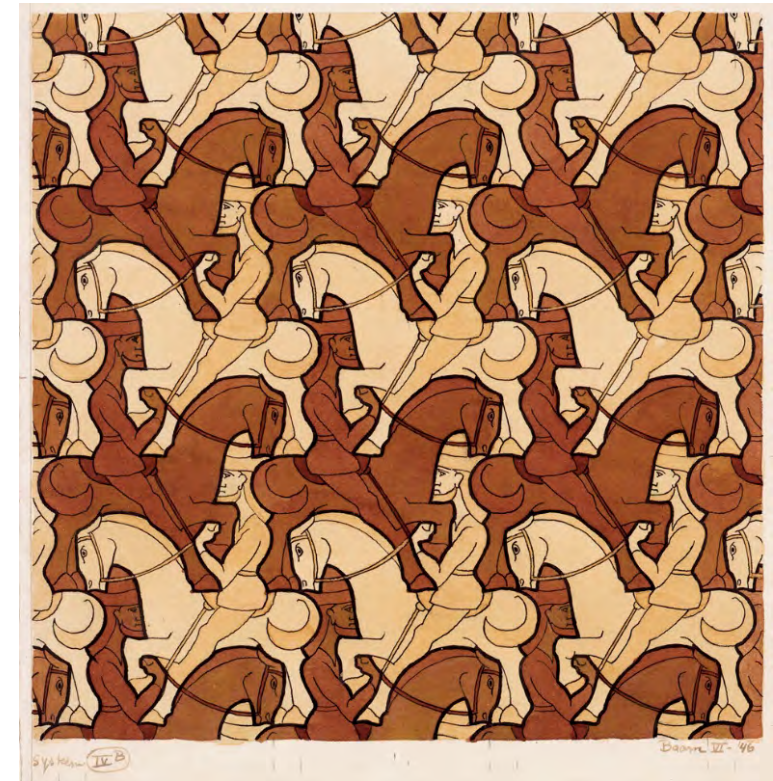
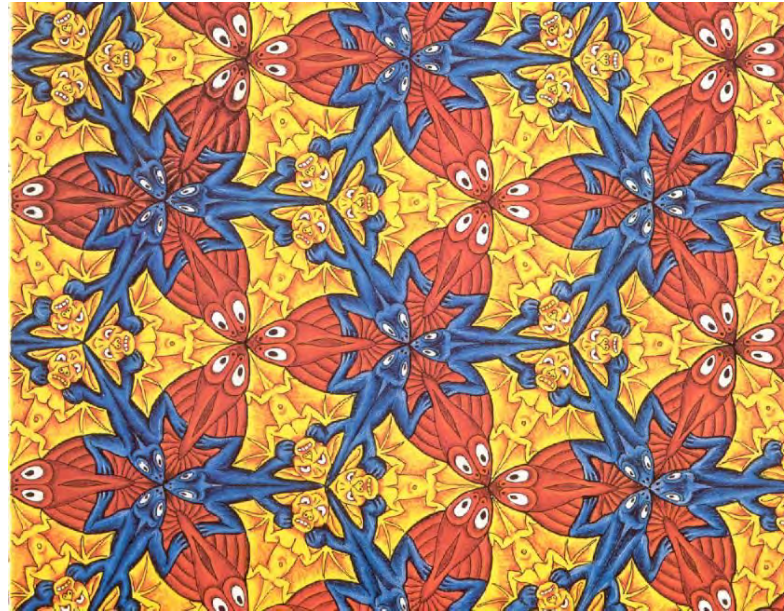



Space Group Determination

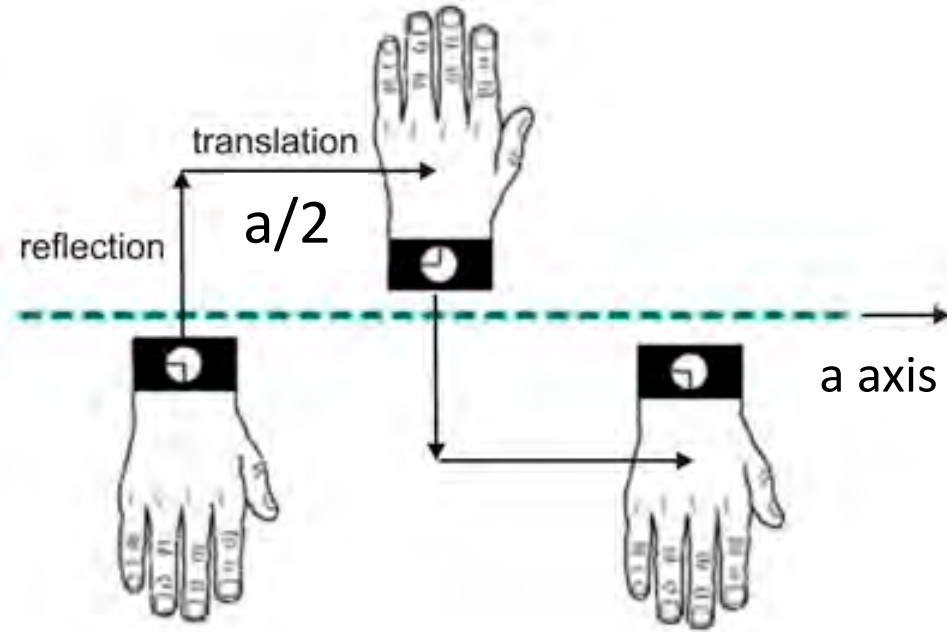
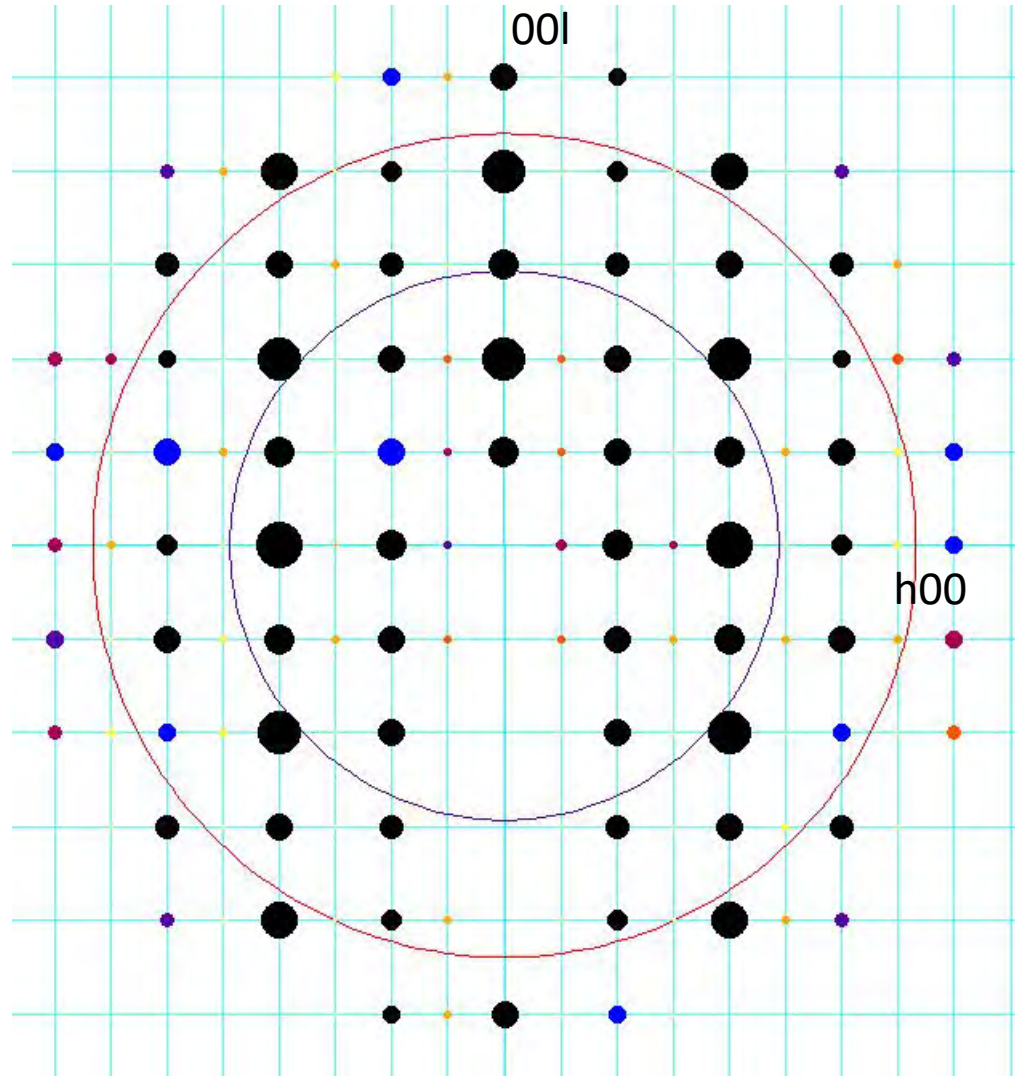

Space Group Determination



3.1. SPACE-GROUP DETERMINATION AND DIFFRACTION SYMBOLS

Table 3.1.4.1. Reflection conditions, diffraction symbols and possible space groups (cont.)

ORTHORHOMBIC, Laue class mmm ($2/m\ 2/m\ 2/m$) (cont.)

Reflection conditions								Laue class mmm ($2/m\ 2/m\ 2/m$)		
hkl	$Ok\bar{l}$	$h0l$	$hk0$	$h00$	$0k0$	$00l$	Extinction symbol	Point group		
								222	$mm2$ $m2m$ $2mm$	mmm
	$k+l$	l	k		k	l	$Pncb$			$Pncb$ (50)
	$k+l$	l	$h+k$	h	k	l	$Pncn$			$Pncn$ (52)
	$k+l$	$h+l$		h	k	l	$Pnn-$		$Pnn2$ (34)	$Pnnm$ (58)
	$k+l$	$h+l$	h	h	k	l	$Pnna$			$Pnna$ (52)
	$k+l$	$h+l$	k	h	k	l	$Pnnb$			$Pnnb$ (52)
	$k+l$	$h+l$	$h+k$	h	k	l	$Pnnn$			$Pnnn$ (48)
$h+k$	k	h	$h+k$	h	k		$C----$	$C222$ (21)	$Cmm2$ (35)	$Cmmm$ (65)
			$h+k$	h	k	l	$C-2_1$	$C222_1$ (20)	$Cm2m$ (38)	
$h+k$	k	h	h, k	h	k		$C-(ab)$		$C2mm$ (38)	$Cm2e$ (39)
									$C2me$ (39)	
$h+k$	k	h, l	$h+k$	h	k	l	$C-c-$		$Cmc2_1$ (36)	$Cmcm$ (63)
									$C2cm$ (40)	
$h+k$	k	h, l	h, k	h	k	l	$C-c(ab)$		$C2ce$ (41)	$Cmce$ (64)
									$Cmm2$ (36)	$Cmmm$ (65)

Crystal to Structure

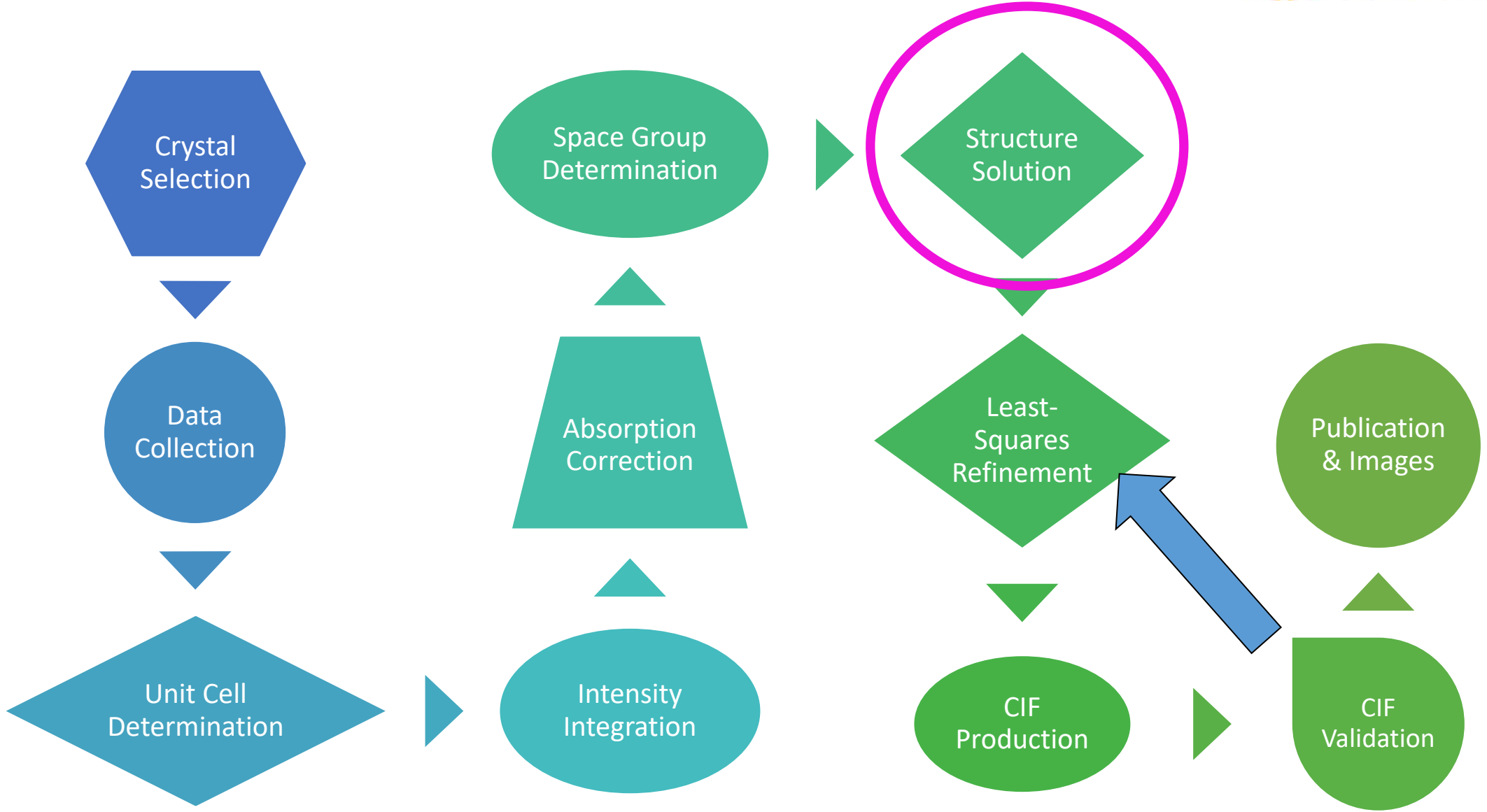



Structure Solution

-5	10	-3	0.01	0.45
-6	10	-3	-0.28	0.49
-7	10	-3	-0.28	0.52
-8	10	-3	1.63	0.56
12	9	-3	1.15	0.68
-12	-9	3	0.64	0.66
11	9	-3	5.65	0.82
-11	-9	3	6.17	0.77
10	9	-3	-0.14	0.65
-10	-9	3	-0.17	0.48
9	9	-3	2.01	0.72
-9	-9	3	2.11	0.51
8	9	-3	4.10	0.72
8	9	-3	6.25	0.82
-8	-9	3	5.89	0.63
7	9	-3	9.05	0.95
-7	-9	3	9.79	0.79
6	9	-3	4.40	0.72
-6	-9	3	7.25	0.65
5	9	-3	8.03	0.84
-5	-9	3	7.17	0.73
4	9	-3	5.66	0.71
-4	-9	3	4.98	0.65
3	9	-3	1.28	0.51
-3	-9	3	1.40	0.46
2	9	-3	18.66	1.23
-2	-9	3	16.45	1.18
1	9	-3	8.06	0.84
-1	-9	3	7.75	0.75
0	0	3	17.88	1.22

$$\rho_{xyz} = \frac{1}{V} \sum_{hkl} \bar{F}_{hkl} e^{-i2\pi(hx+ky+lz)}$$

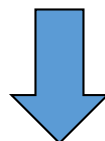

$$\bar{F}_{hkl} = |F_{hkl}| e^{i\varphi_{hkl}}$$

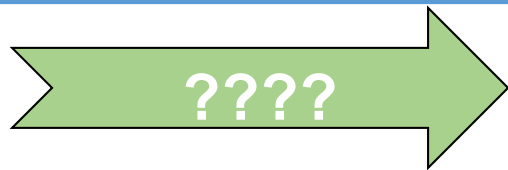

SHELXT
SHELXS
SIR2011+
SUPERFLIP

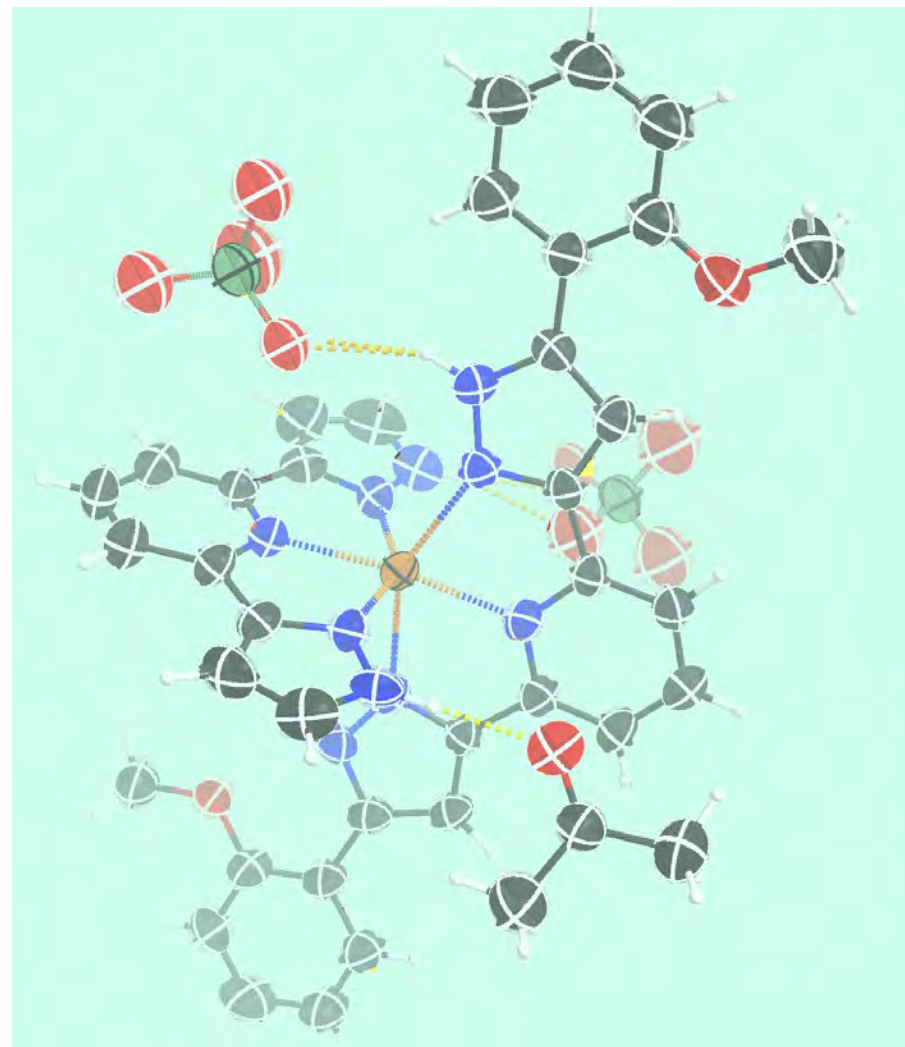



What is a Structure?

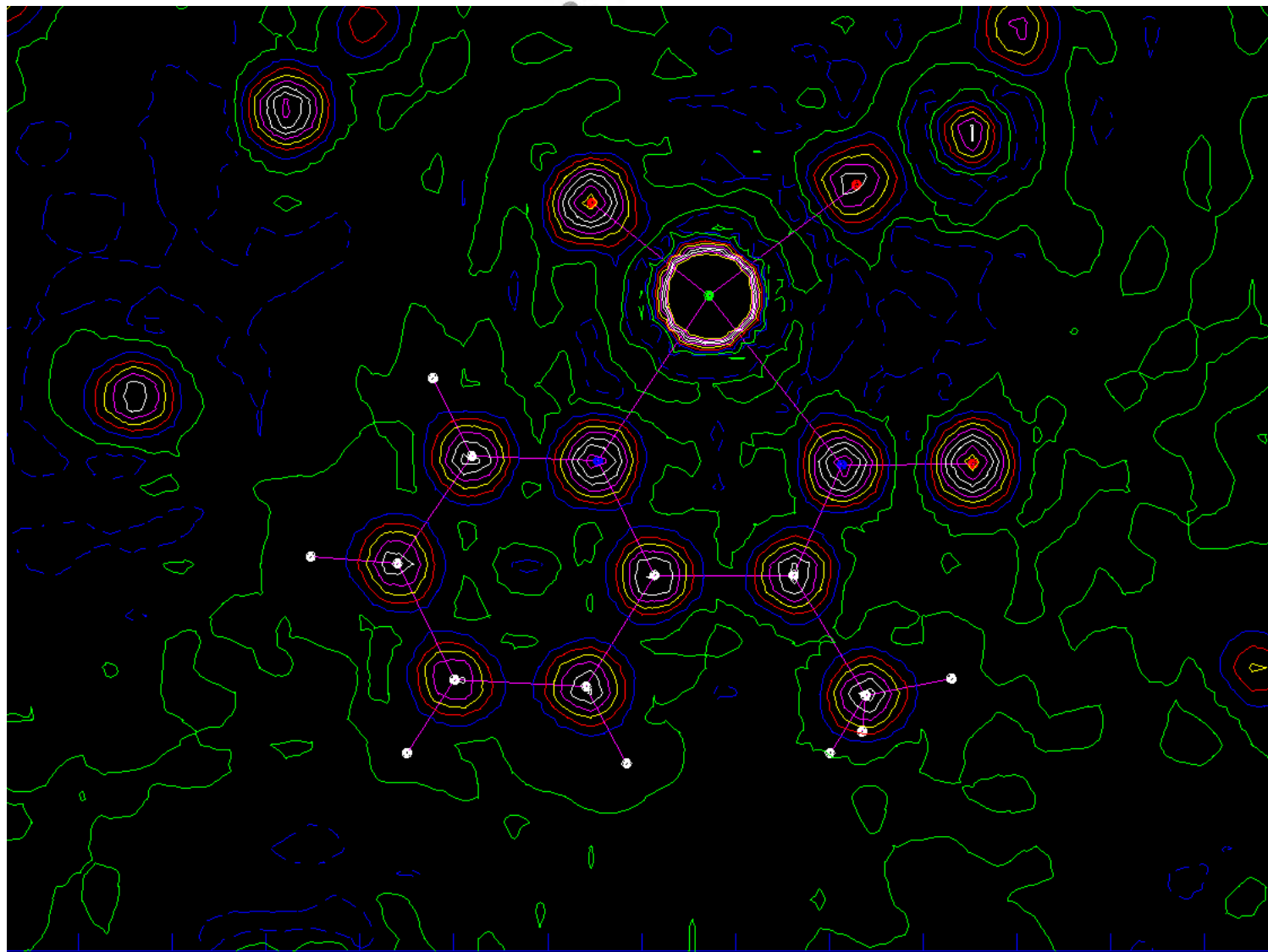

1-D Electron Density Map



$$\rho_h = \frac{1}{V} \sum_h |F_h| \cos(2\pi(hx - \varphi))$$

$$\rho_h = \frac{1}{V} \sum_h \bar{F}_h e^{-i2\pi hx}$$

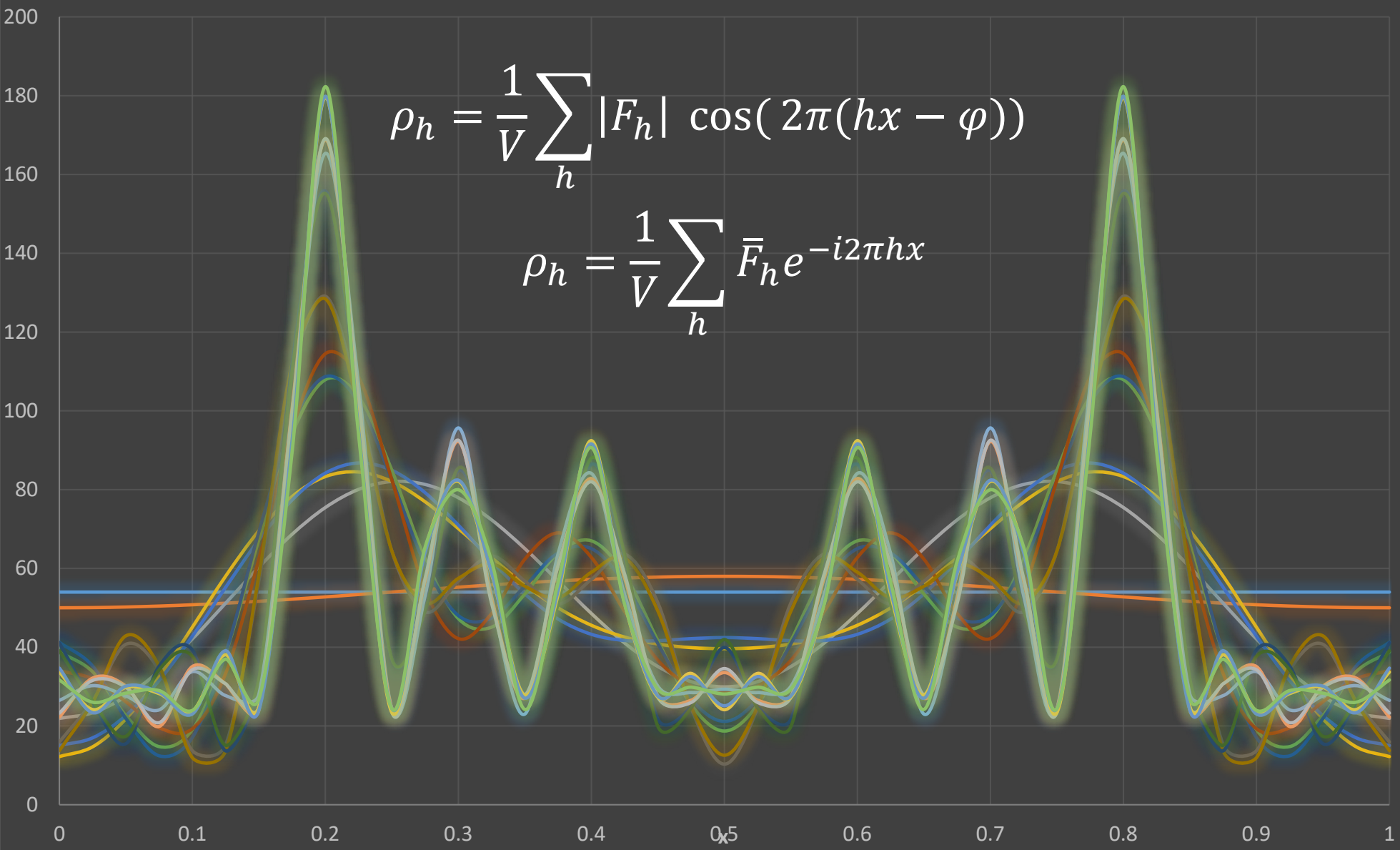



Fobs Map at 2.50Å

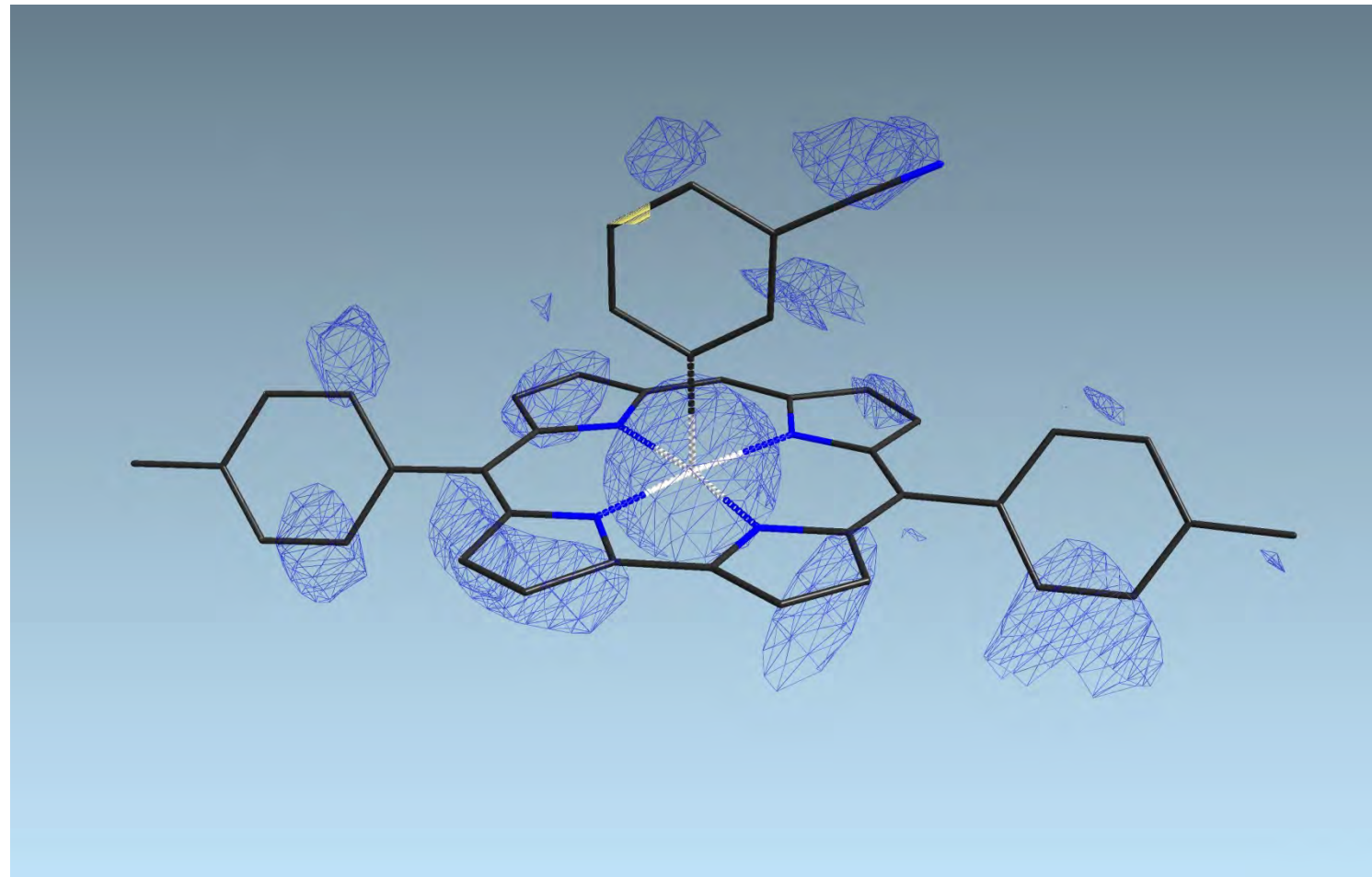

Fobs Map at 2.0Å

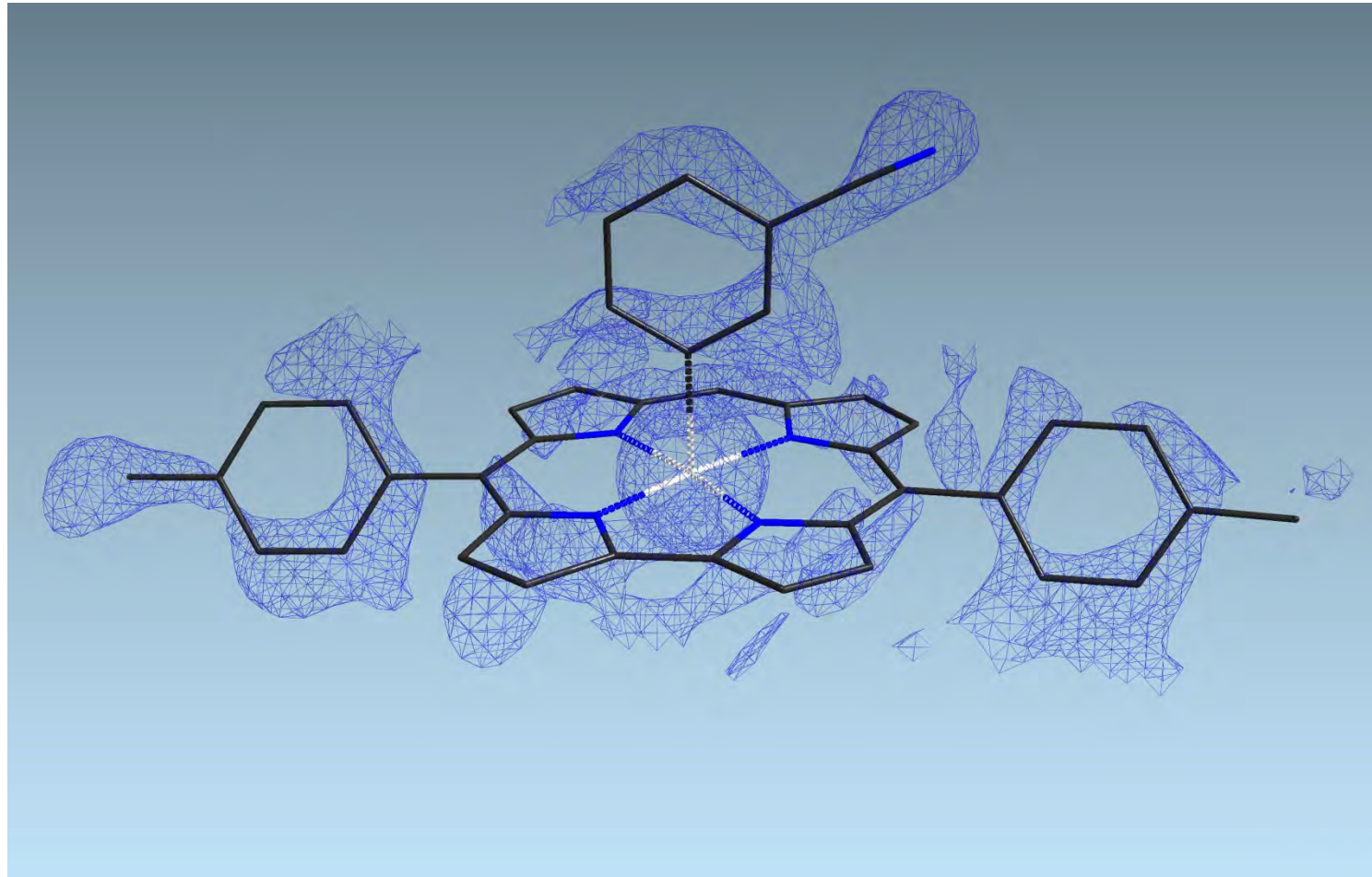

Fobs Map at 1.75Å

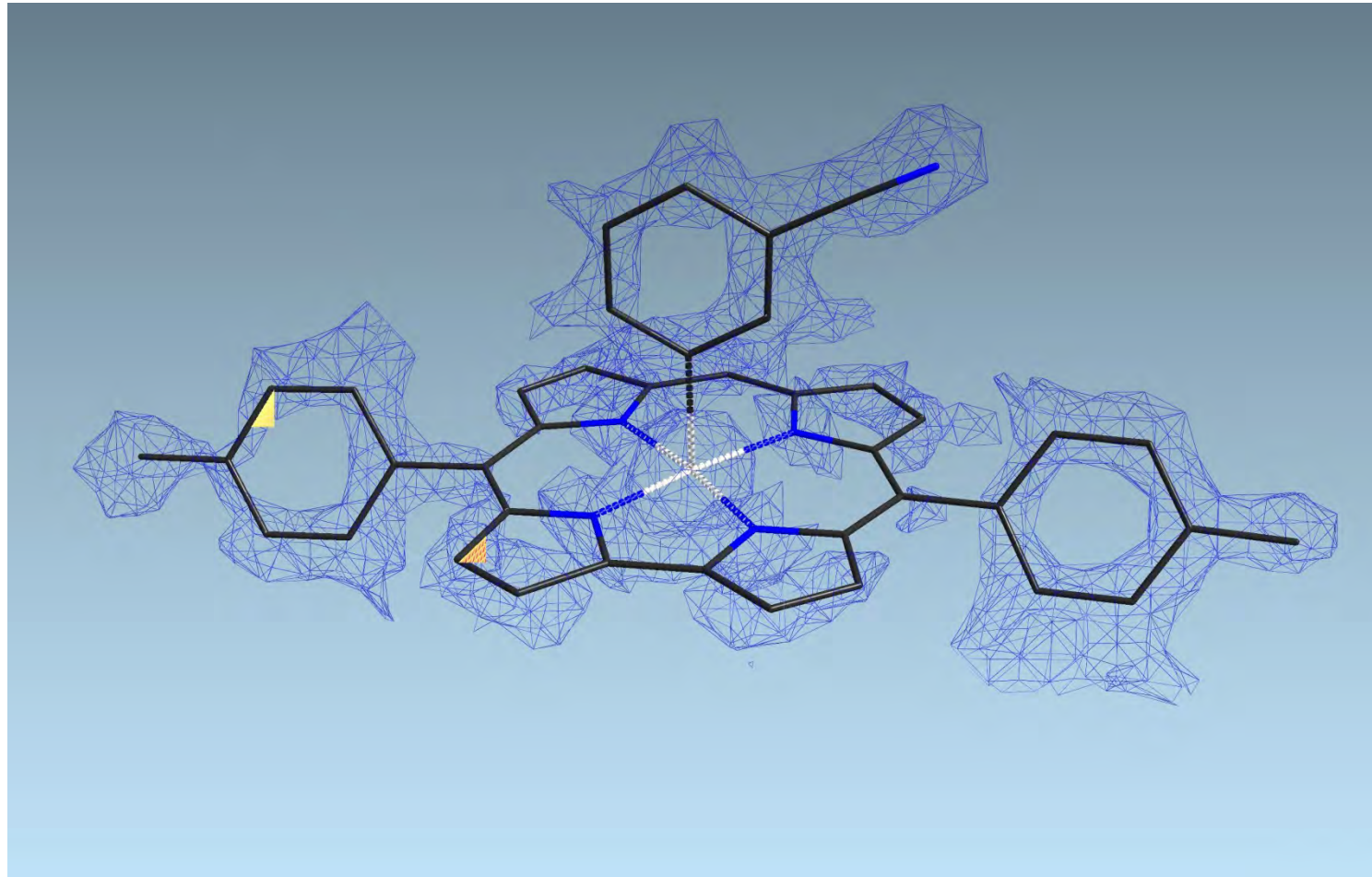

Fobs Map at 1.50Å

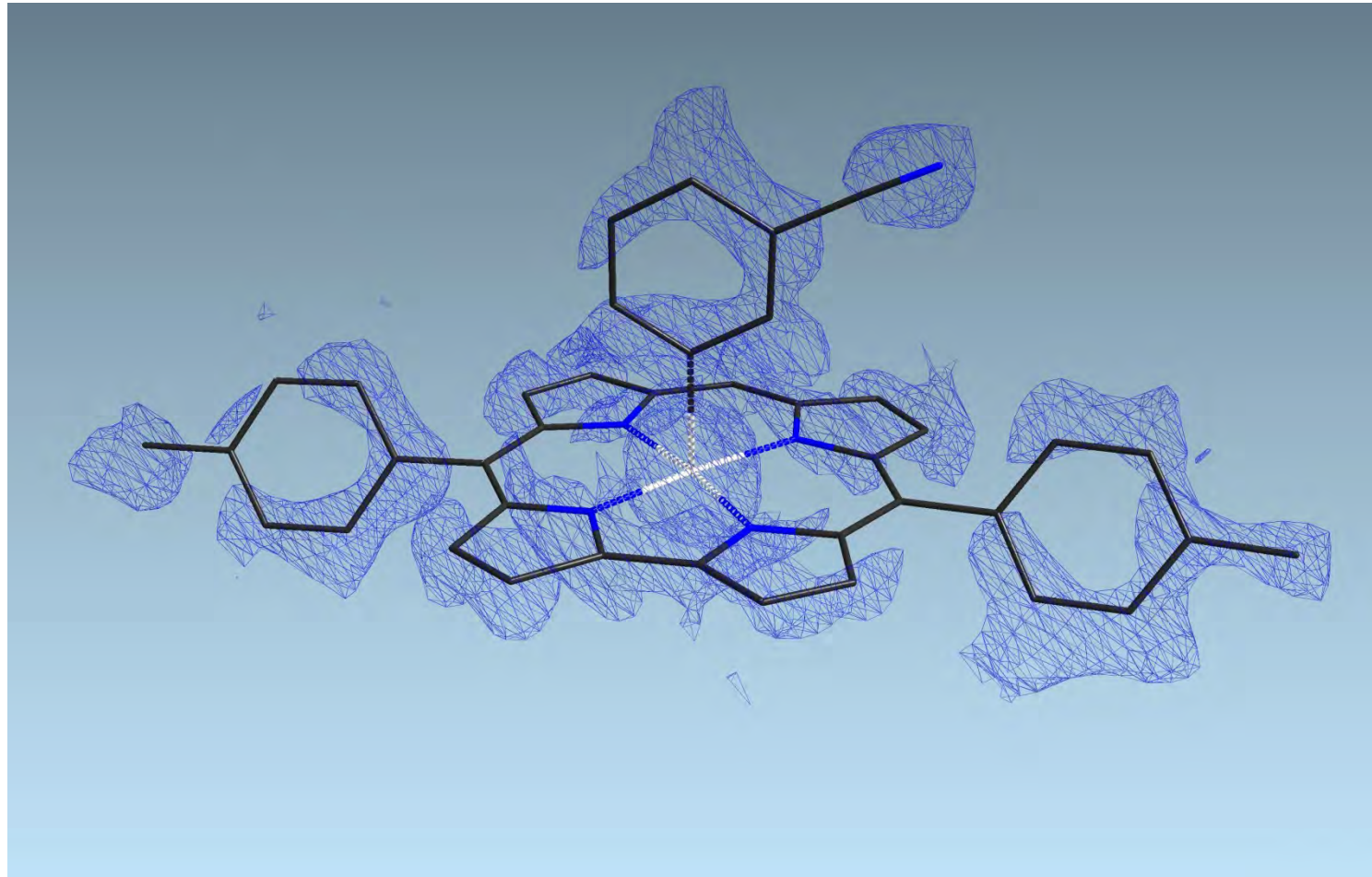

Fobs Map at 1.25Å

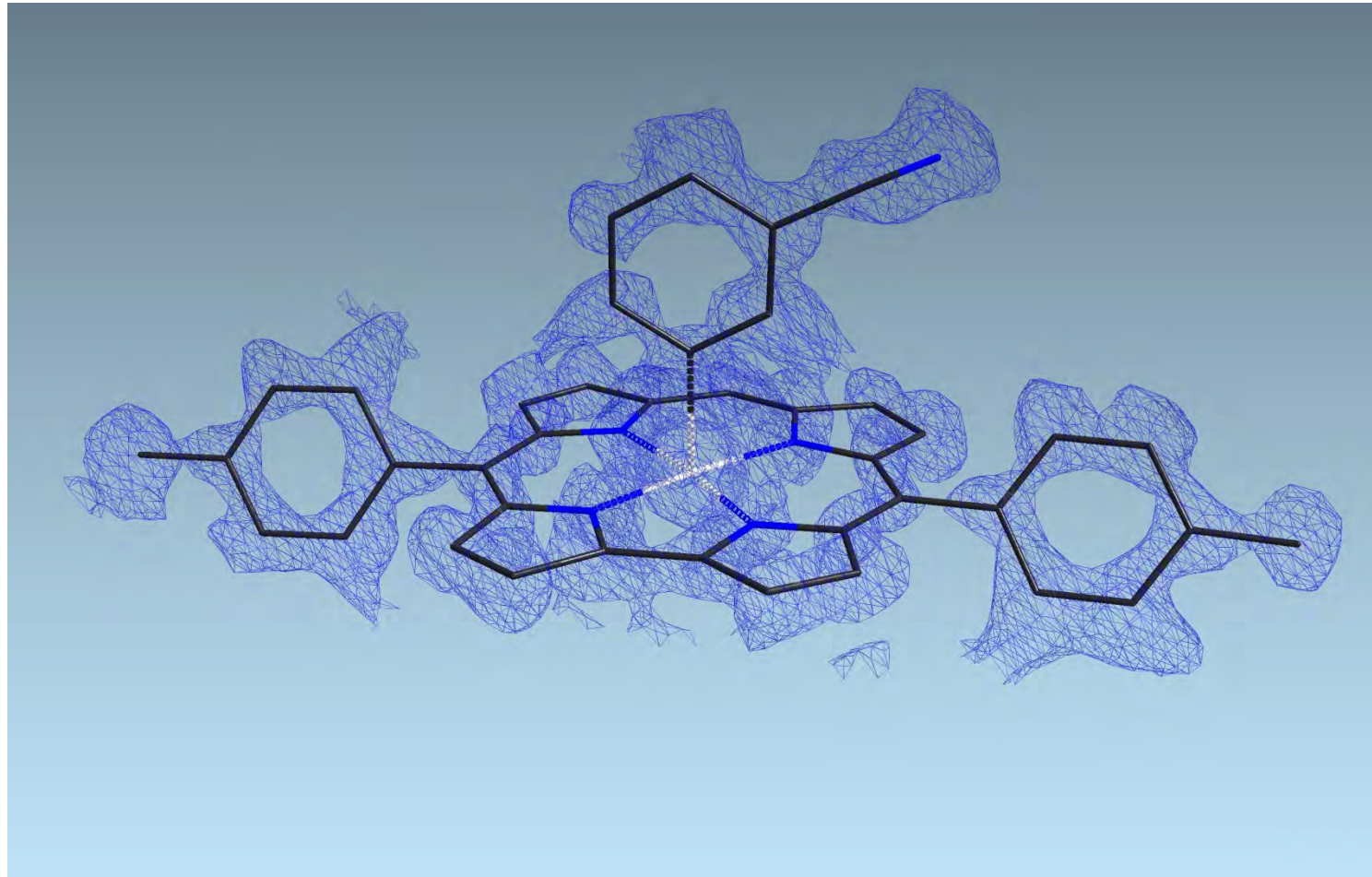

Fobs Map at 1.00Å

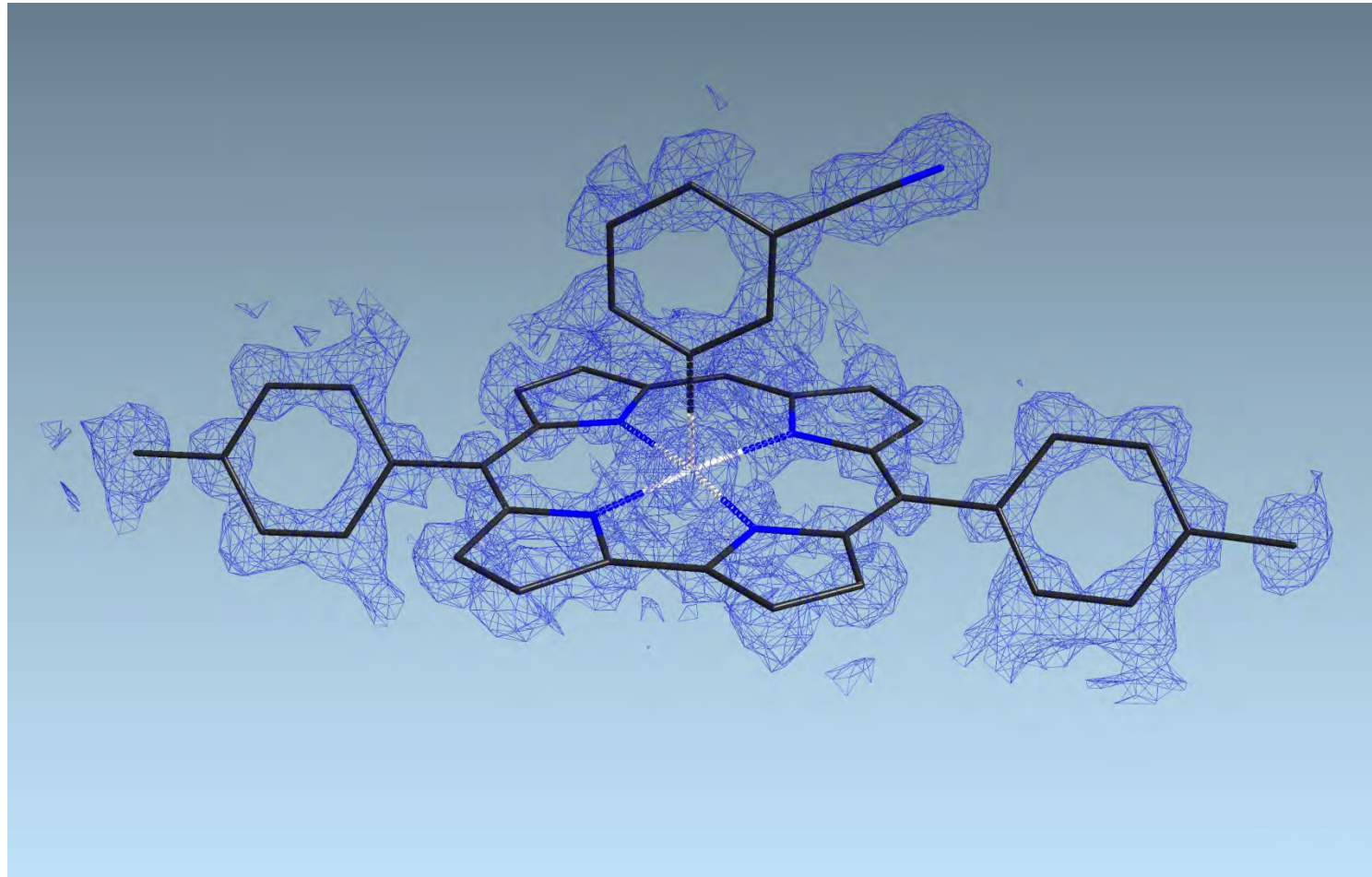

Fobs Map at 0.75Å

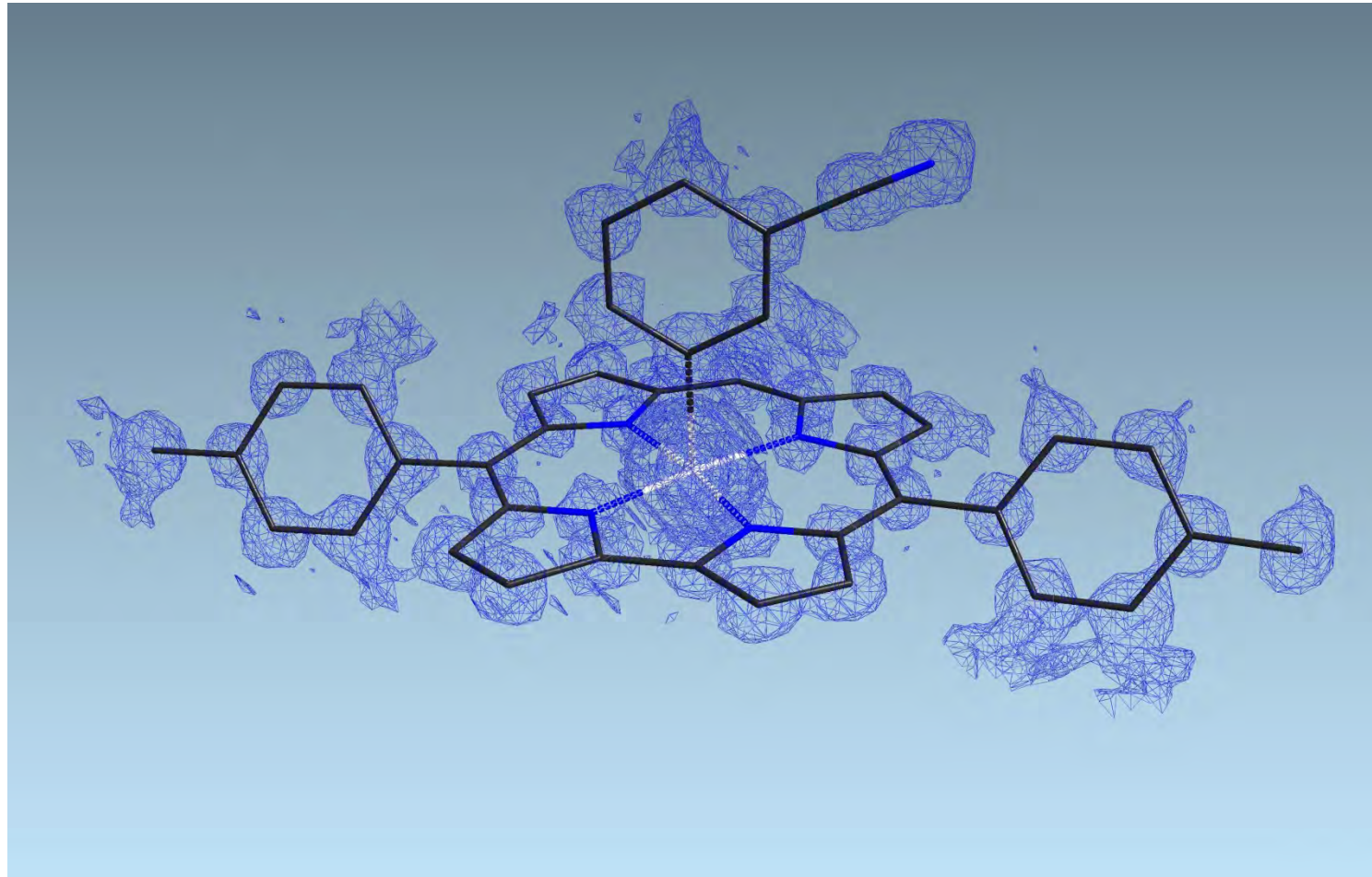

Fobs Map at 0.50Å

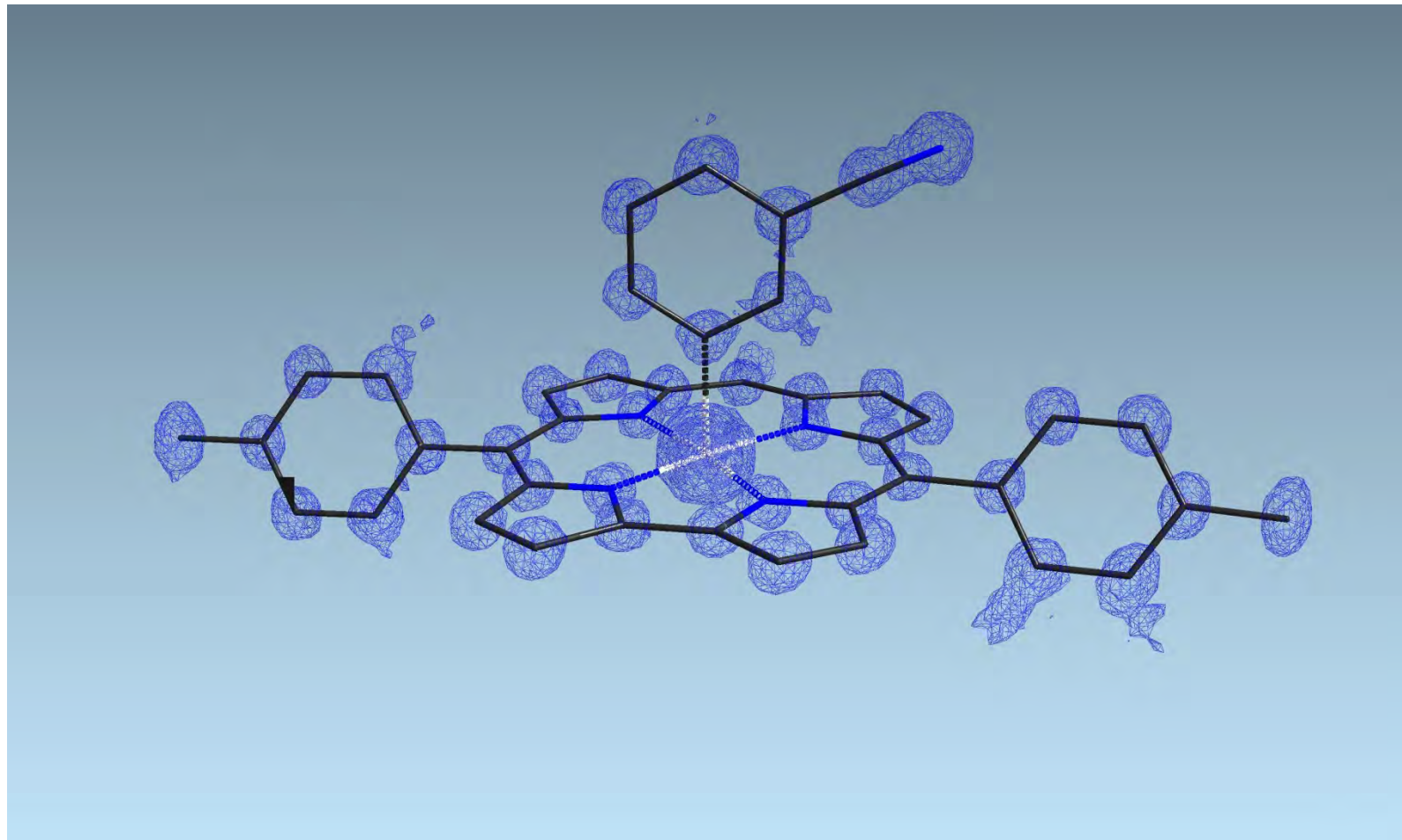

F_{obs} and Difference Map 0.5Å

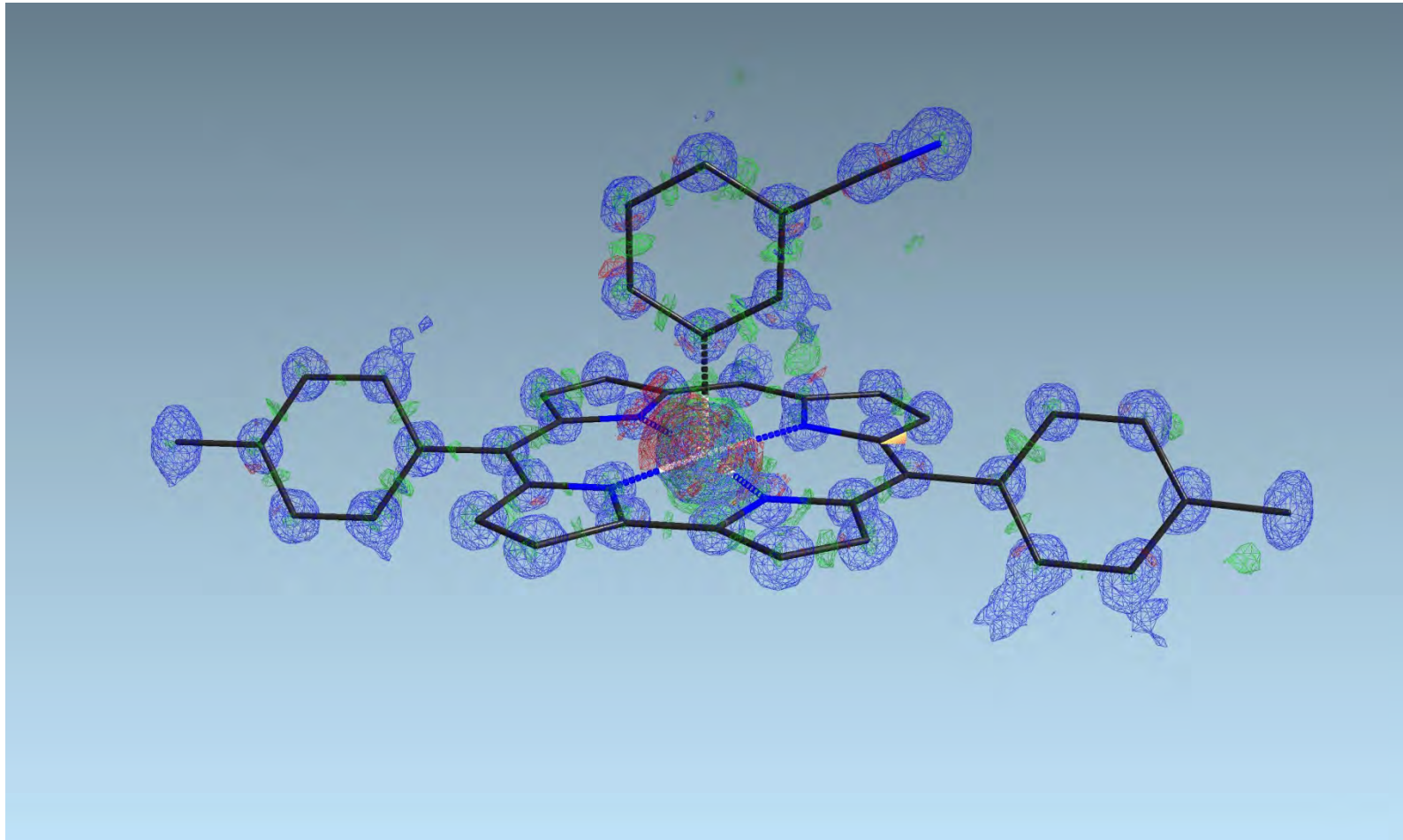

Crystal to Structure

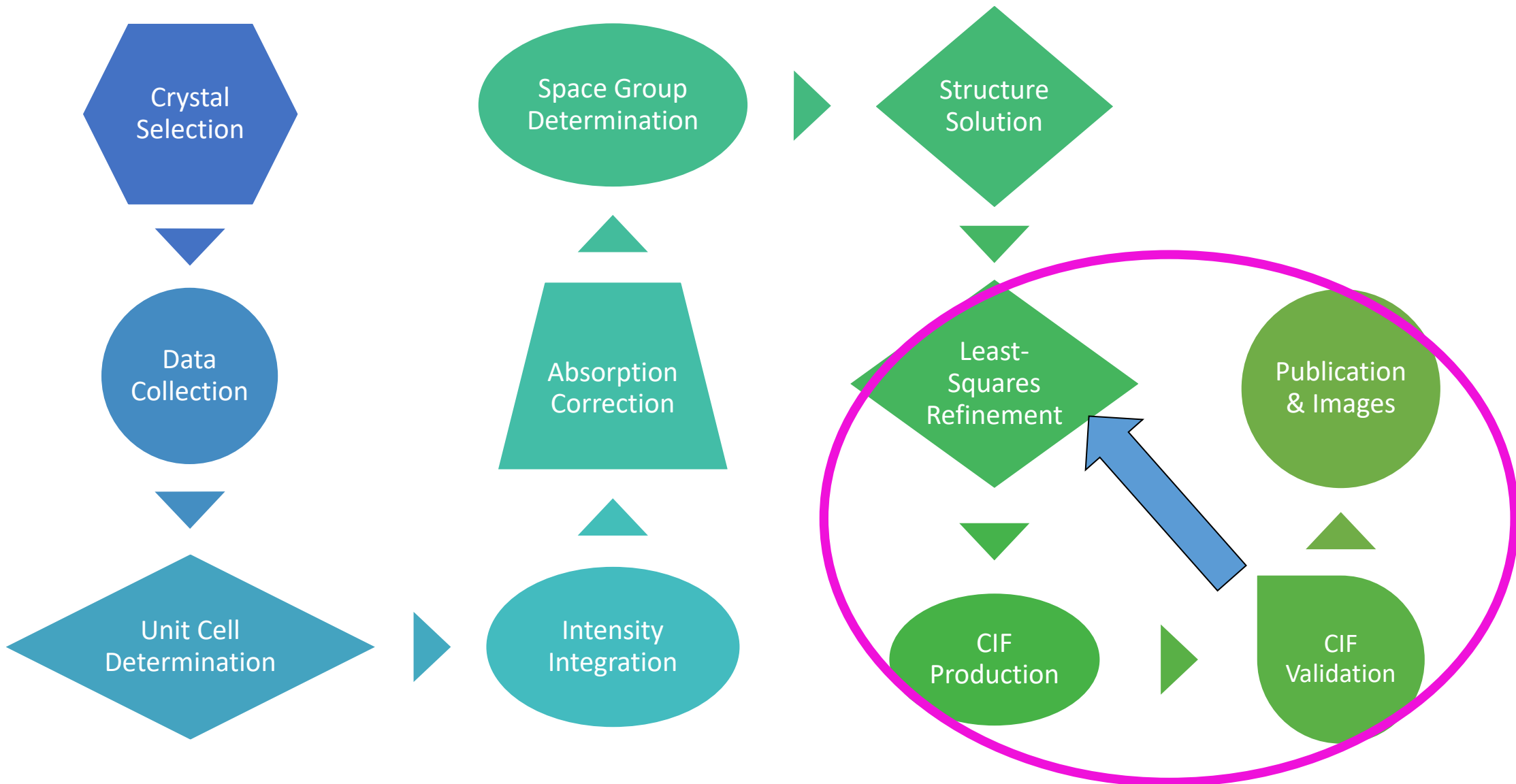



Refinement & Validation

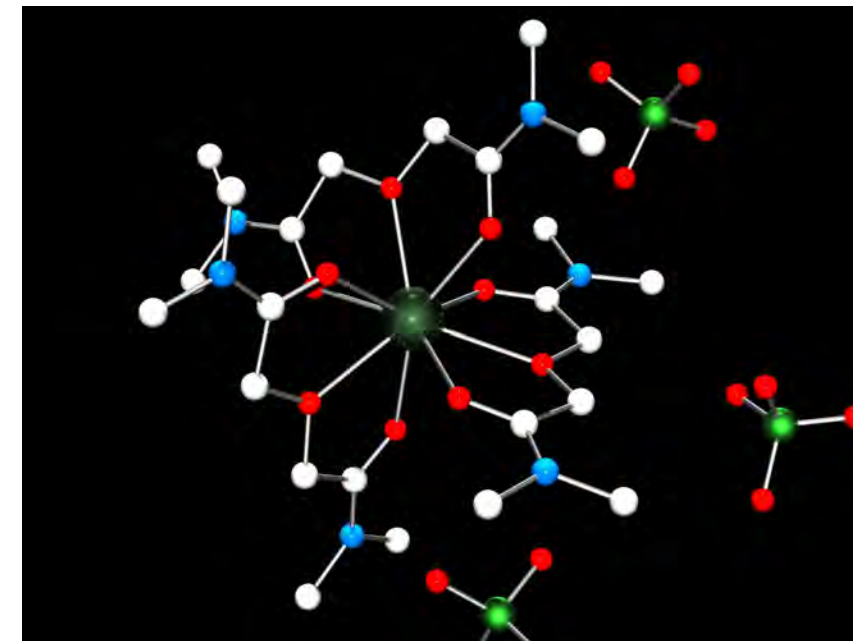
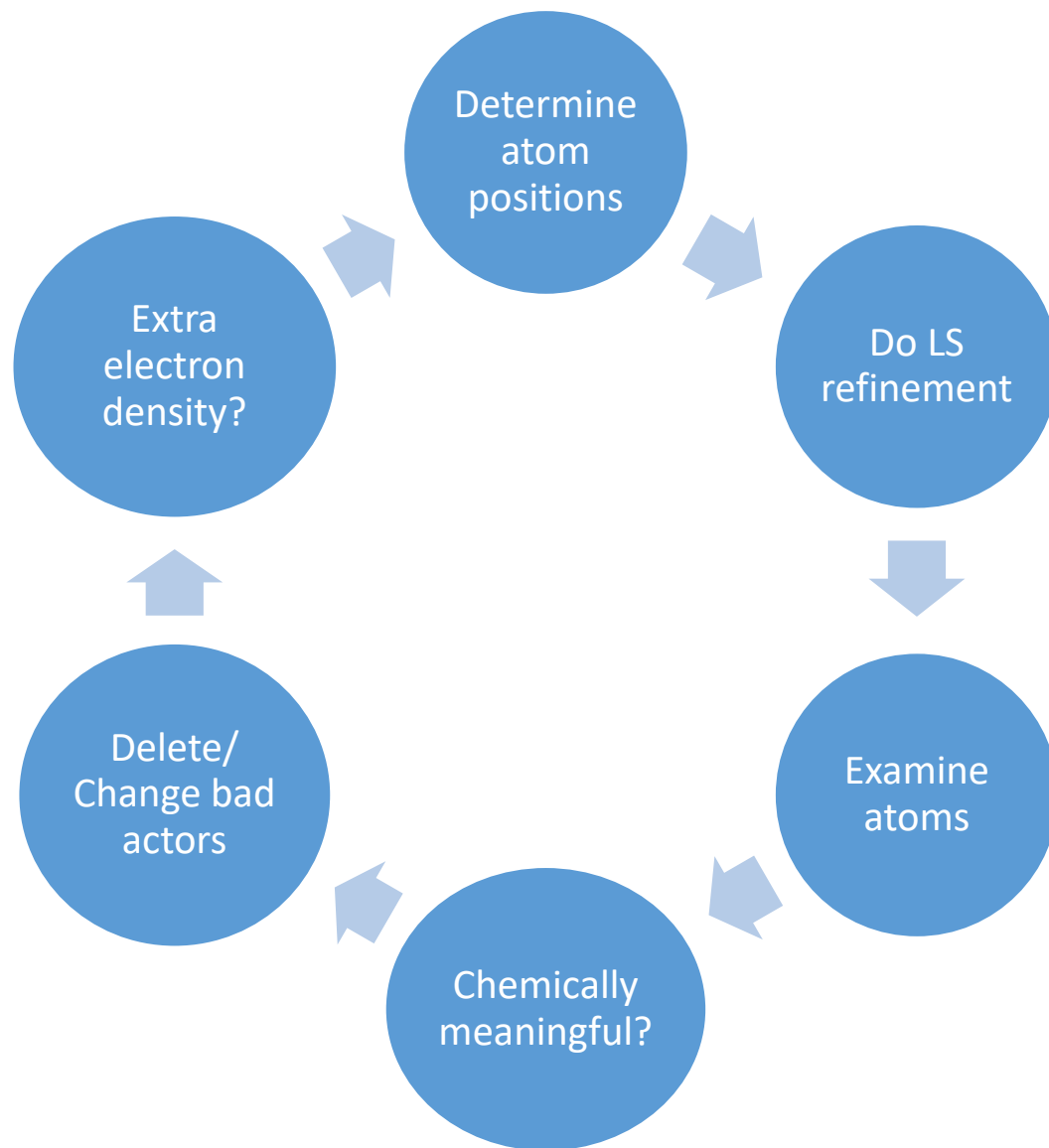

$$R_1 = \frac{\sum_{hkl} ||F_{obs}| - |F_{calc}||}{\sum_{hkl} ||F_{obs}||}$$

$$wR_2 = \sqrt{\frac{\sum_{hkl} w(F_{obs}^2 - F_{calc}^2)^2}{\sum_{hkl} w(F_{obs}^2)^2}}$$

For More Information

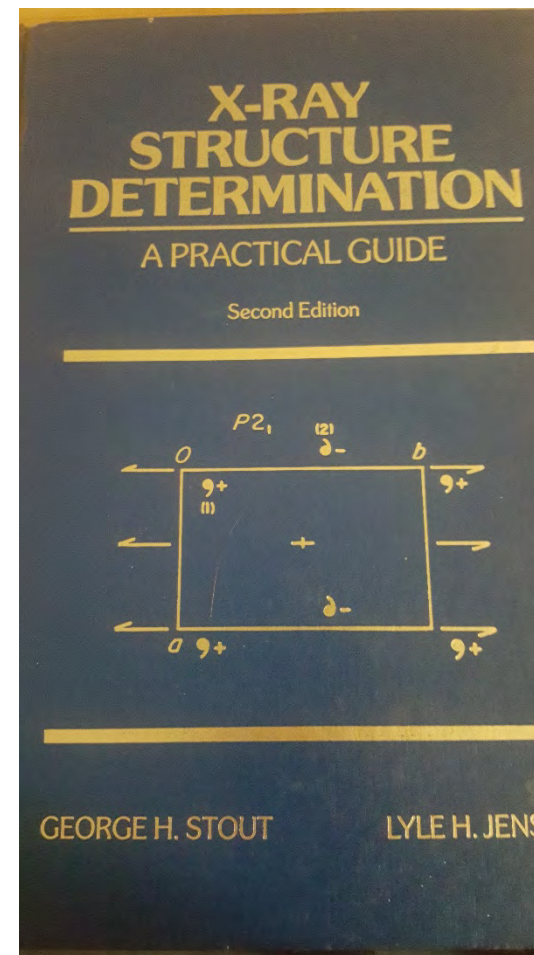
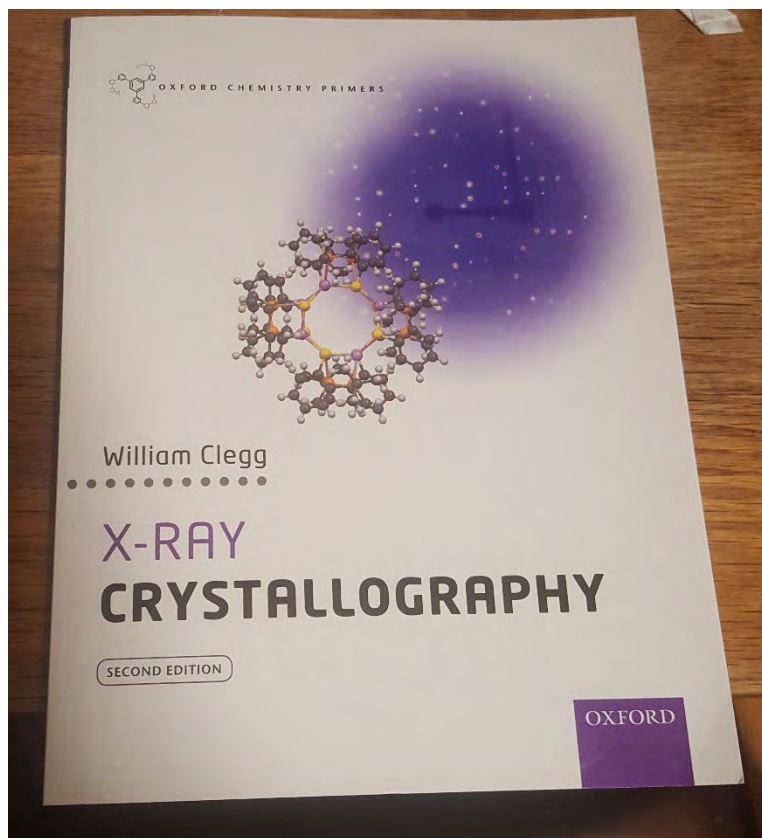

Even More Information

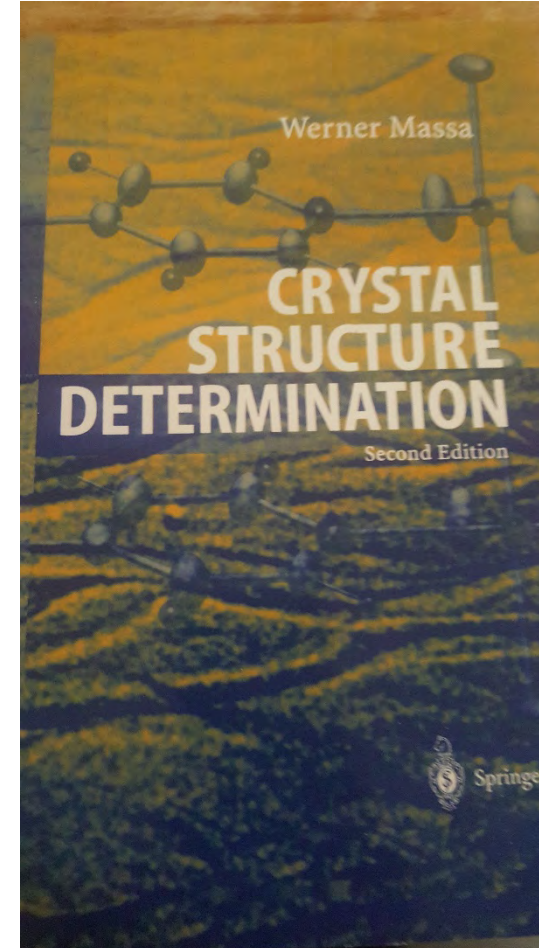
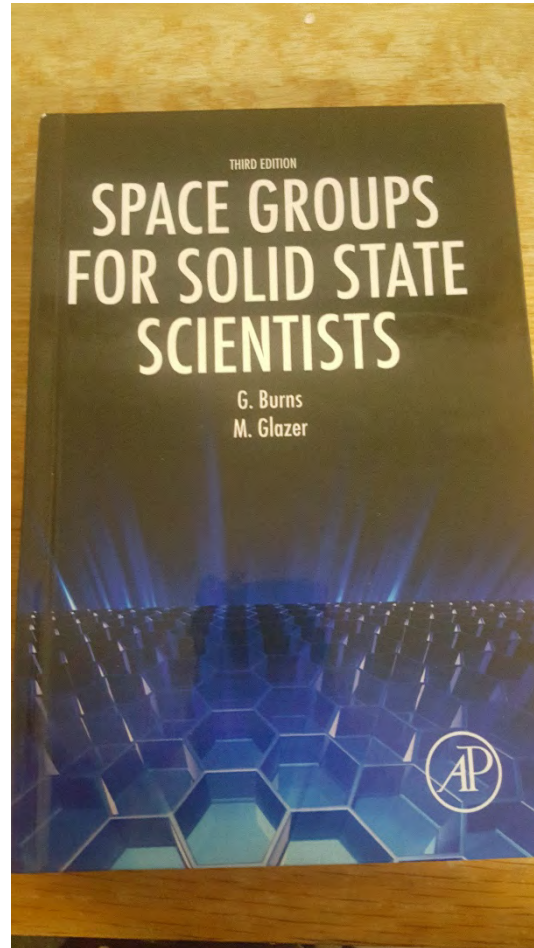

More Resources!!!



Internet

- X-ray Forum
 - www.xrayforum.co.uk/
- IUCr Forum
 - forums.iucr.org
- CCP4
 - <http://www.ccp4.ac.uk>

Small Molecule Crystallography at a Synchrotron

or

What can you do with more flux?

Contents



- Why do crystals diffract poorly?
- What can we do to them to make them diffract poorly?
- What can we learn from poorly diffracting crystals?
- What do synchrotrons have to do with all this?



The Spectrum of Crystallinity



- Perfect crystals
 - Diffract dynamically, Bragg

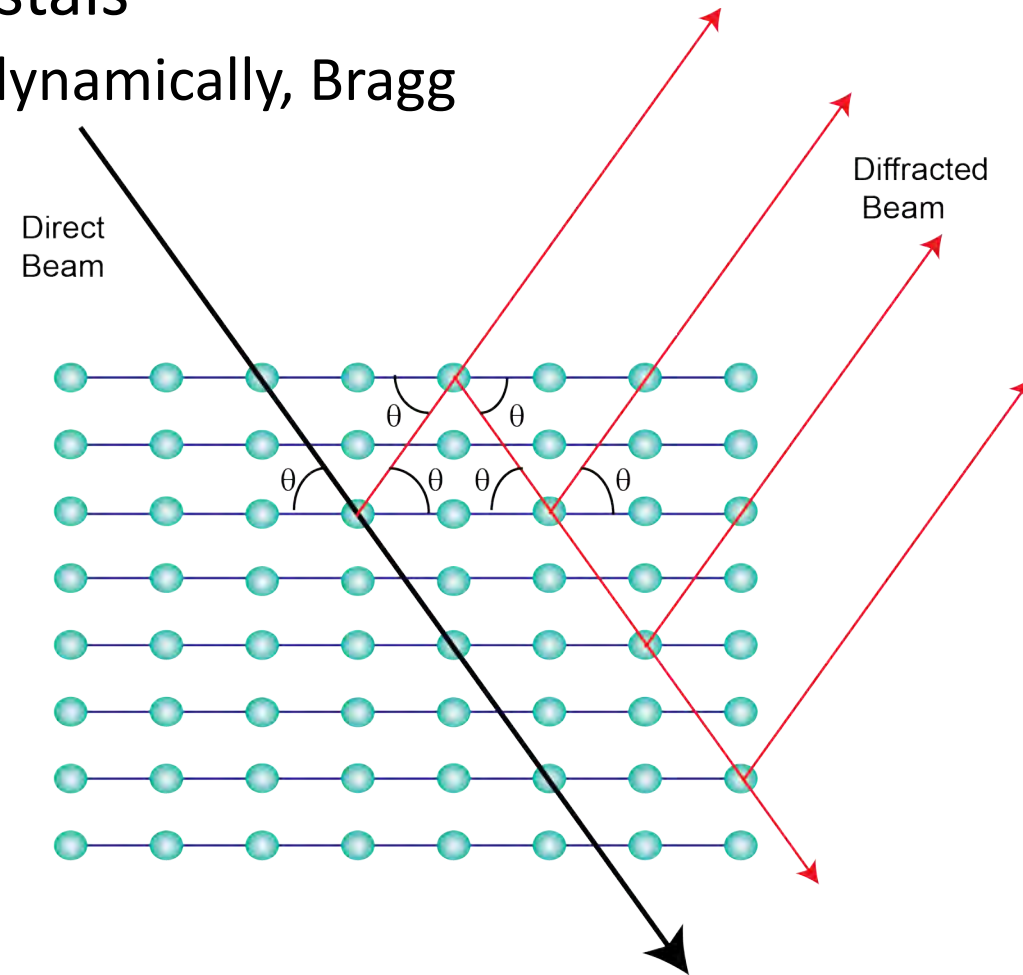

The Spectrum of Crystallinity



- Good Crystals
 - Diffract kinematically(Bragg), due to mosaicity, but still have good long range order

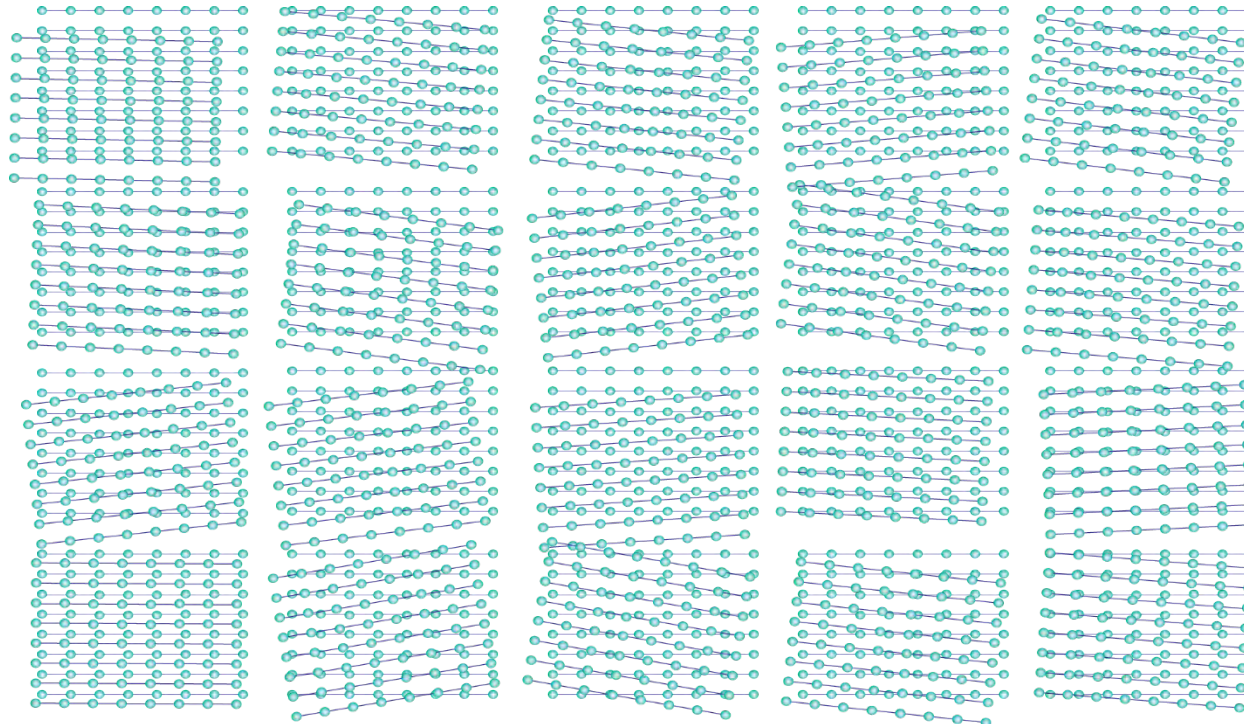



The Spectrum of Crystallinity



- Poor crystals

- Diffract kinematically(Bragg), but diffraction limited due to poor long range order.
- Can show powder Laue rings/spot smearing due to mosaicity becoming microcrystallinity
- Can also display non-Bragg scatter due to TDS

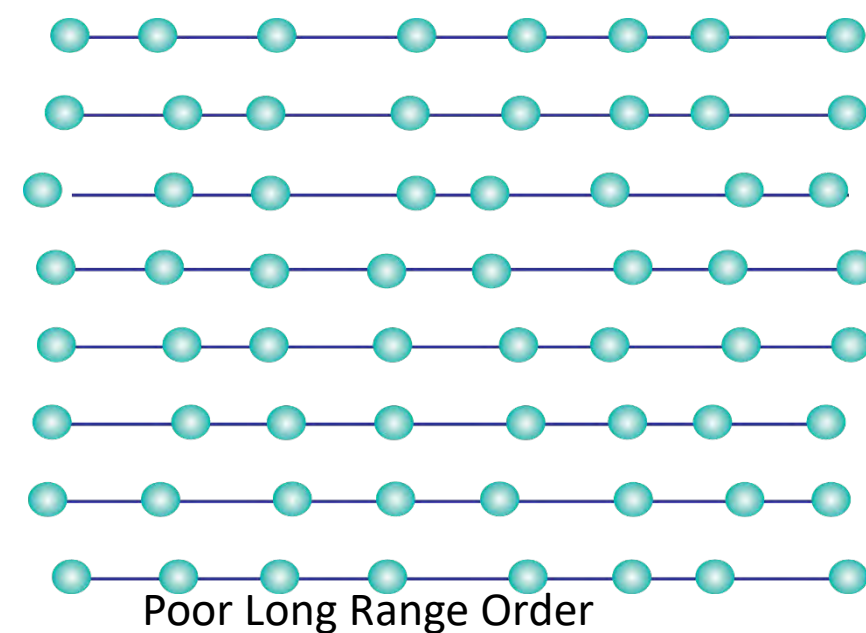
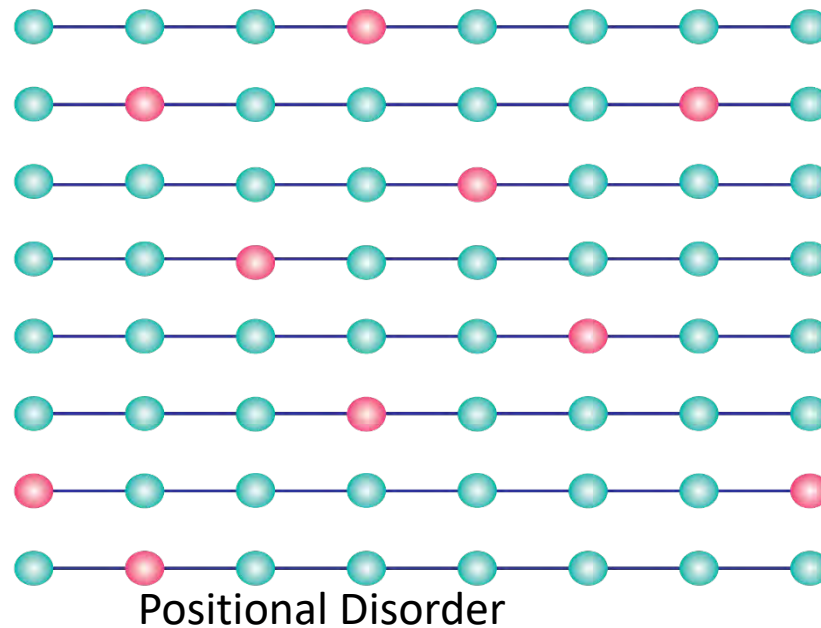

Scattering Efficiency



$$\textit{Intensity of Diffraction} \approx \lambda^3 = \frac{LI_{\text{incident}} \langle |F_{hkl}^2| \rangle V_{\text{crystal}}}{V_{\text{cell}}^2}$$

Where:

- F = number of electrons per atom
- V_{crystal} = volume of the crystal
- V_{cell} = volume of the unit cell



Effect of disorder

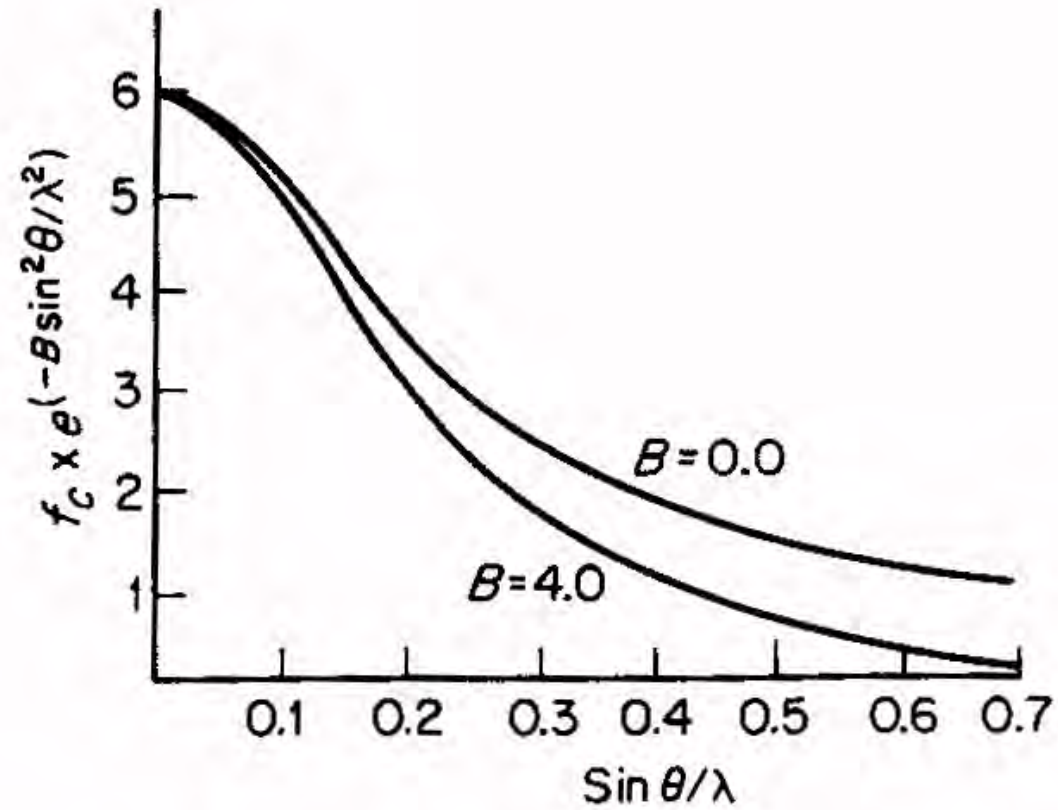



Intensity vs. Displacement

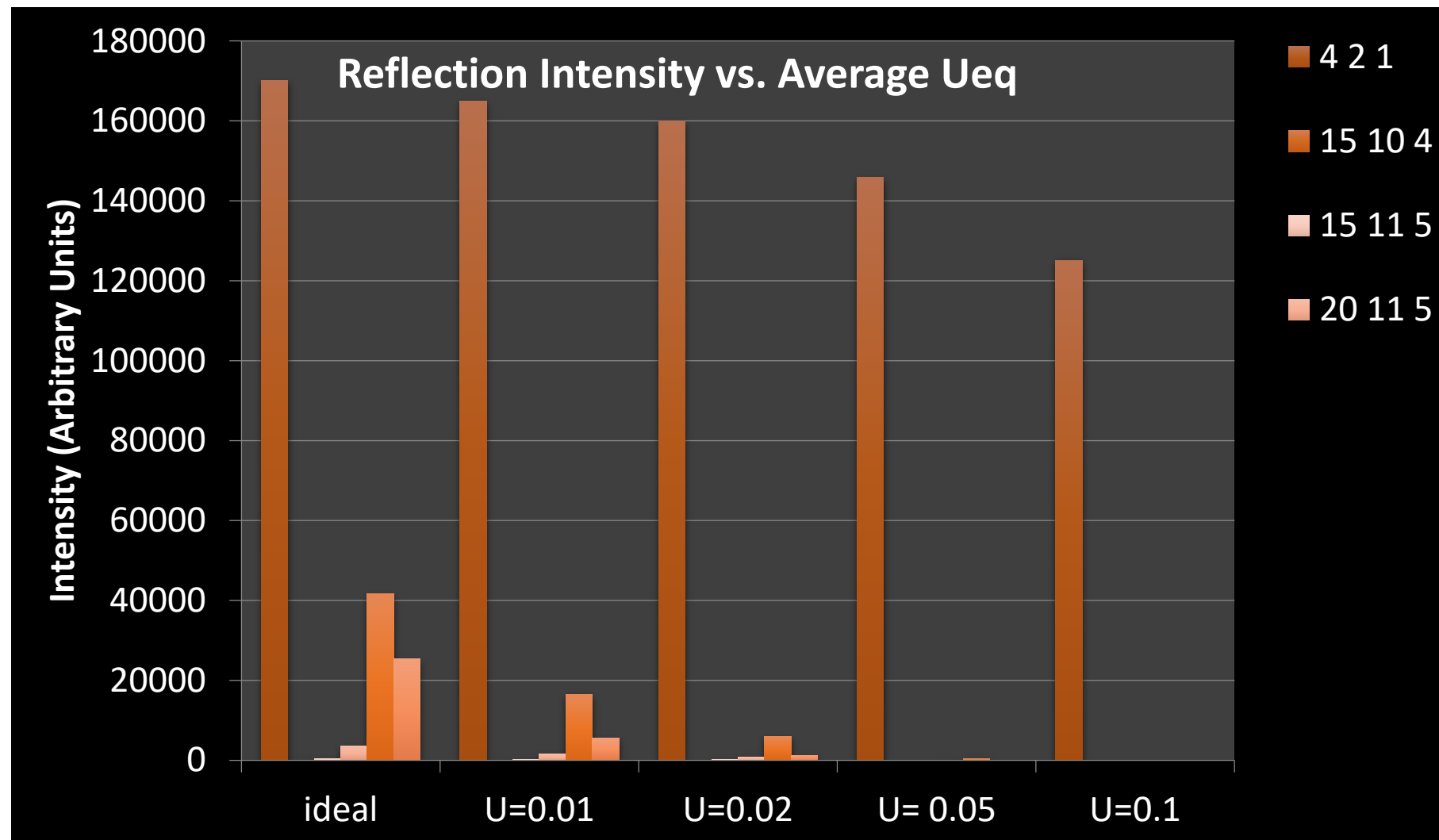



Higher Angle Reflections Affected by Larger ADPs

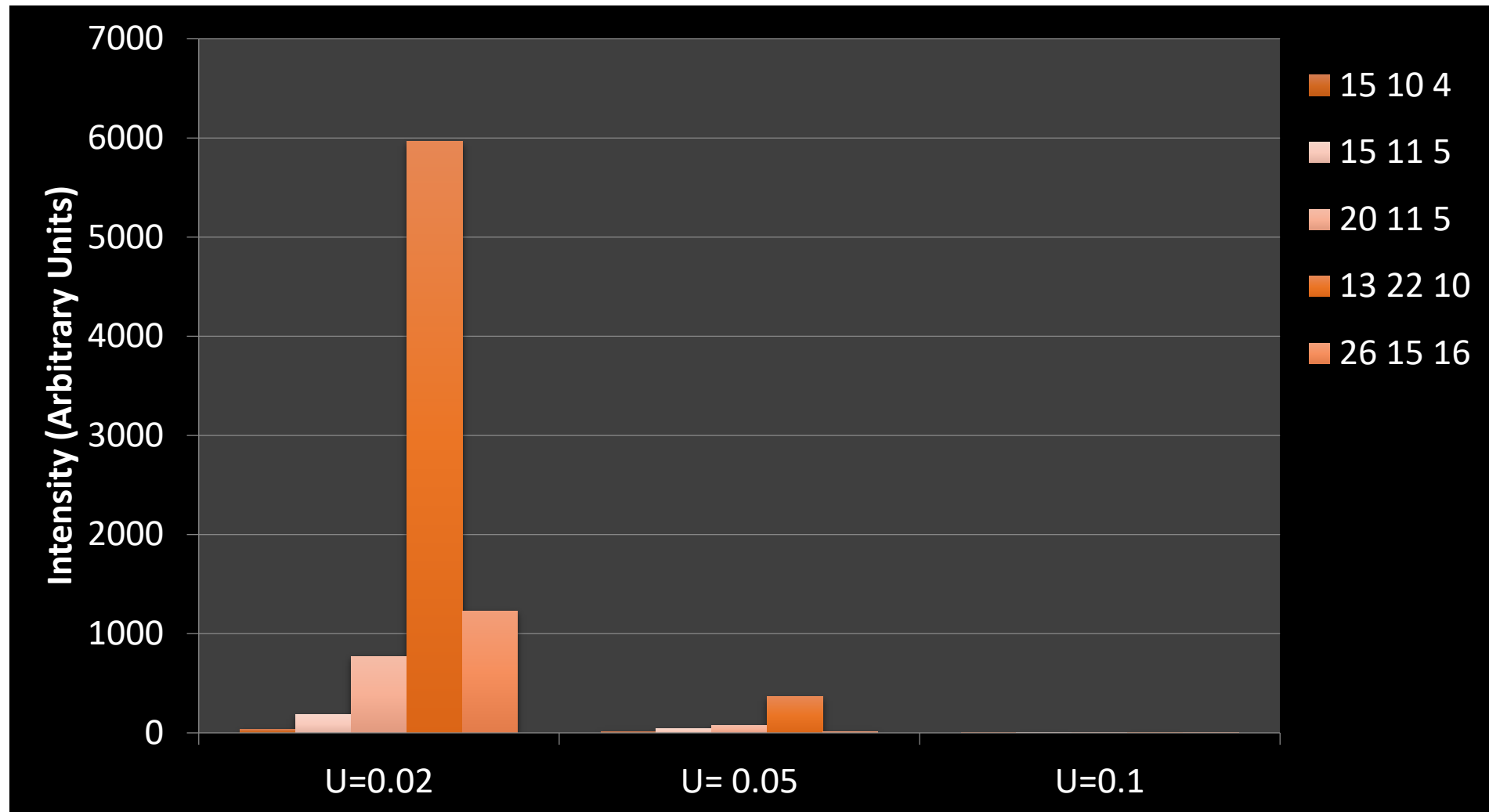

Wavelength



- The material and the wavelength need to be compatible
 - Short wavelengths better for heavy absorbers
 - Long wavelengths better for light atoms (weakly diffracting elements)
 - Be aware of absorption edges and potential fluorescence from sample

Bigger isn't always better



- Large crystals aren't guaranteed to diffract better
- Crystal should match beam size
 - But if there is a choice, smaller than the beam is usually better
- Rocking width can be worse with large crystals due to poor mosaicity



In situ experiments

Structures from change.



In-situ Crystallography



- The application of a stimuli to produce structural change
 - Temperature
 - Pressure
 - Gas or Vacuum
 - Light
 - Electric or Magnetic Fields

Photocrystallography

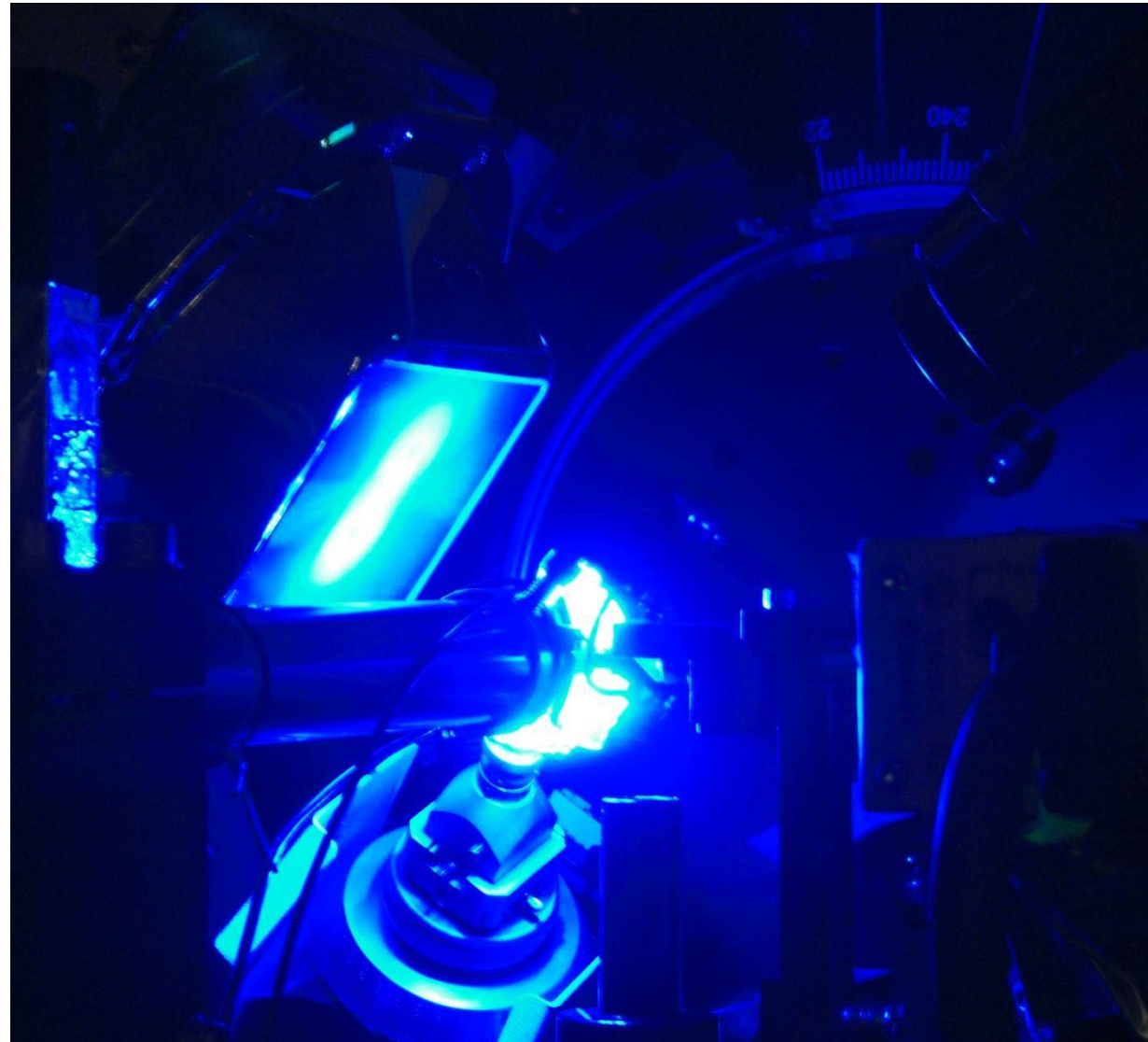

N-bound

nitro

0 %

No irradiation

50 %

10 minutes irradiation

100 %

20 minutes irradiation

O-bound

nitrito

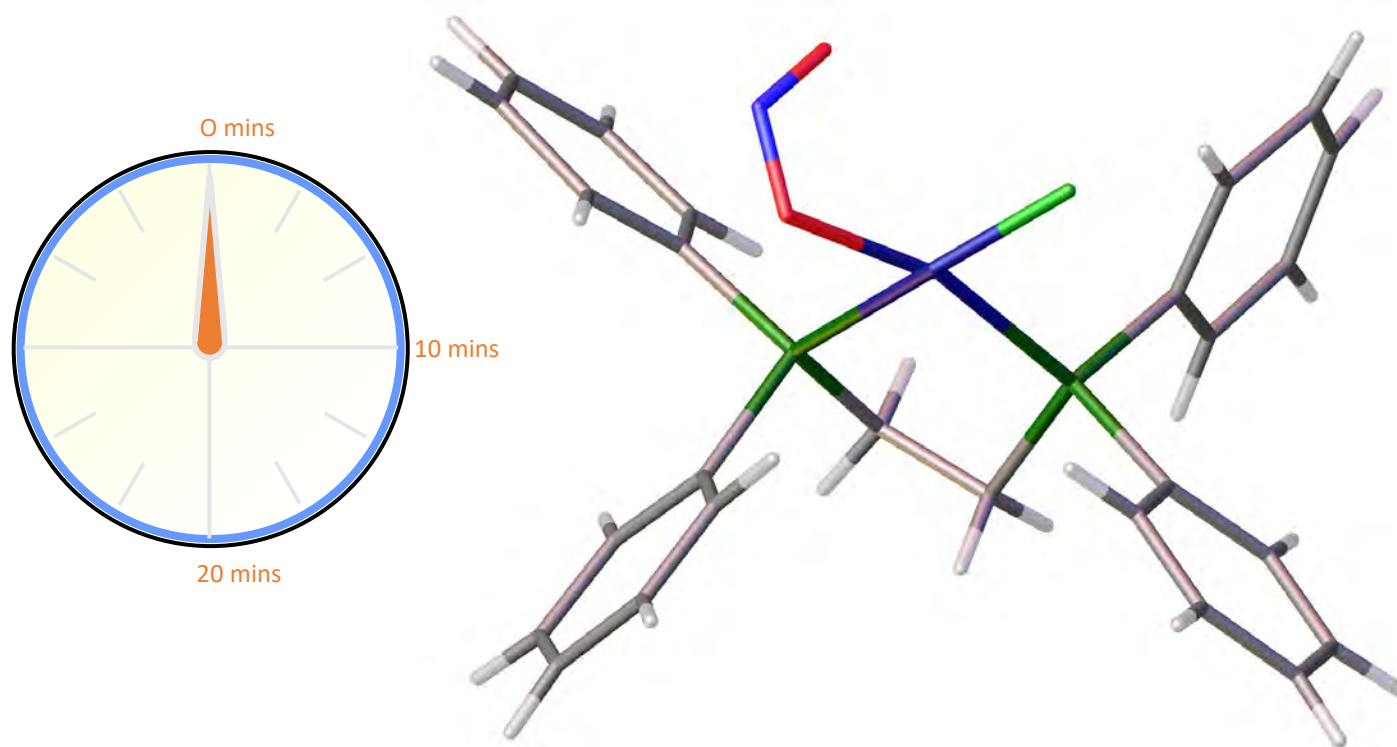

J. Appl. Cryst. 2010, **43**, 337-340

Gas Cell

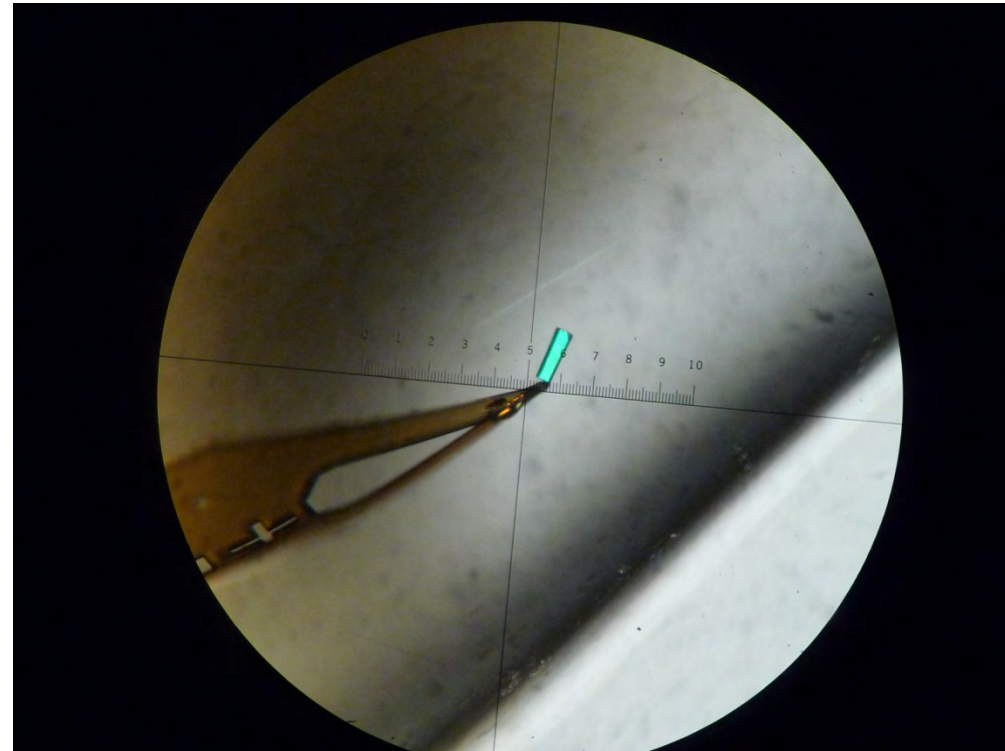

Hydrated MOF

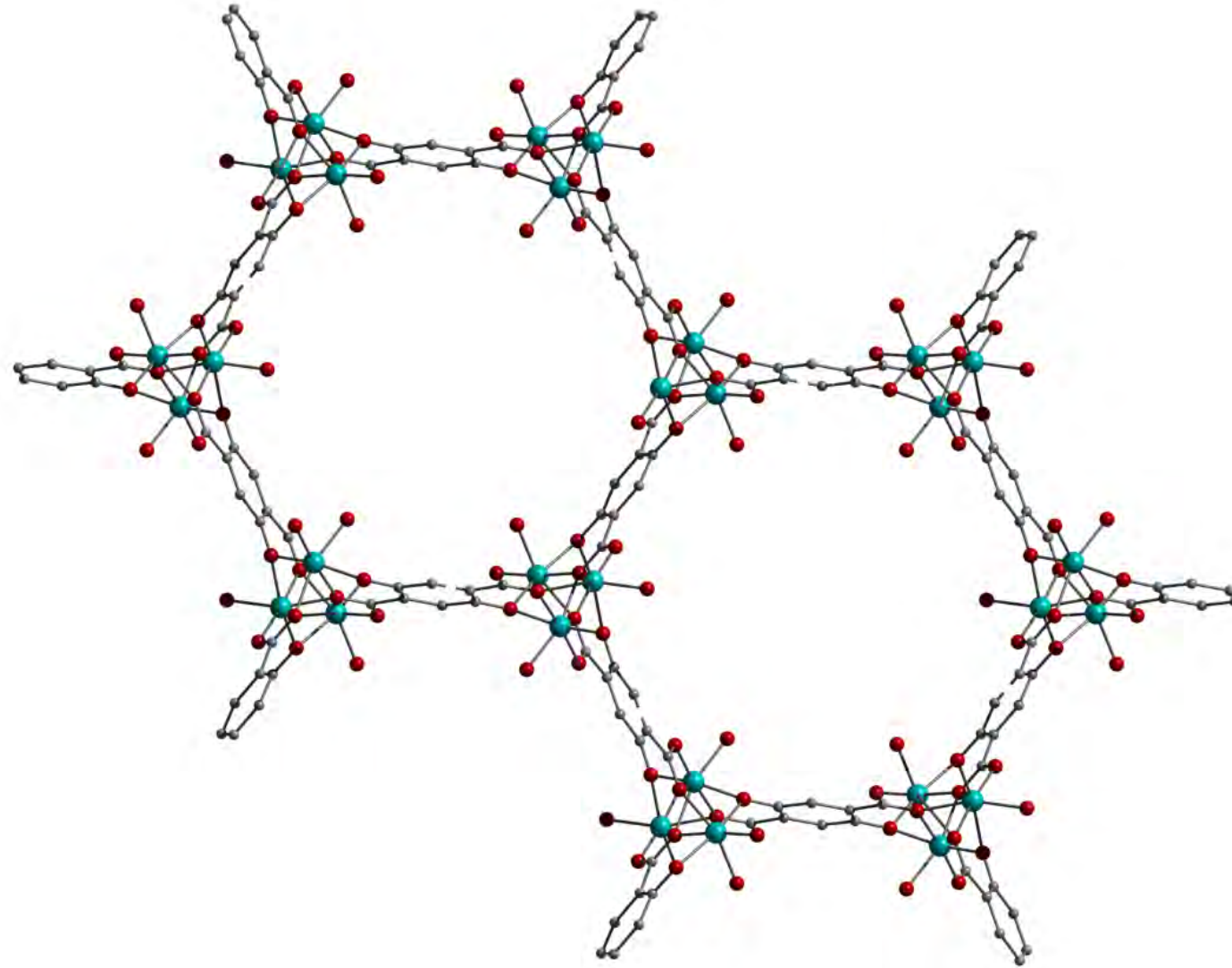

Dehydrated

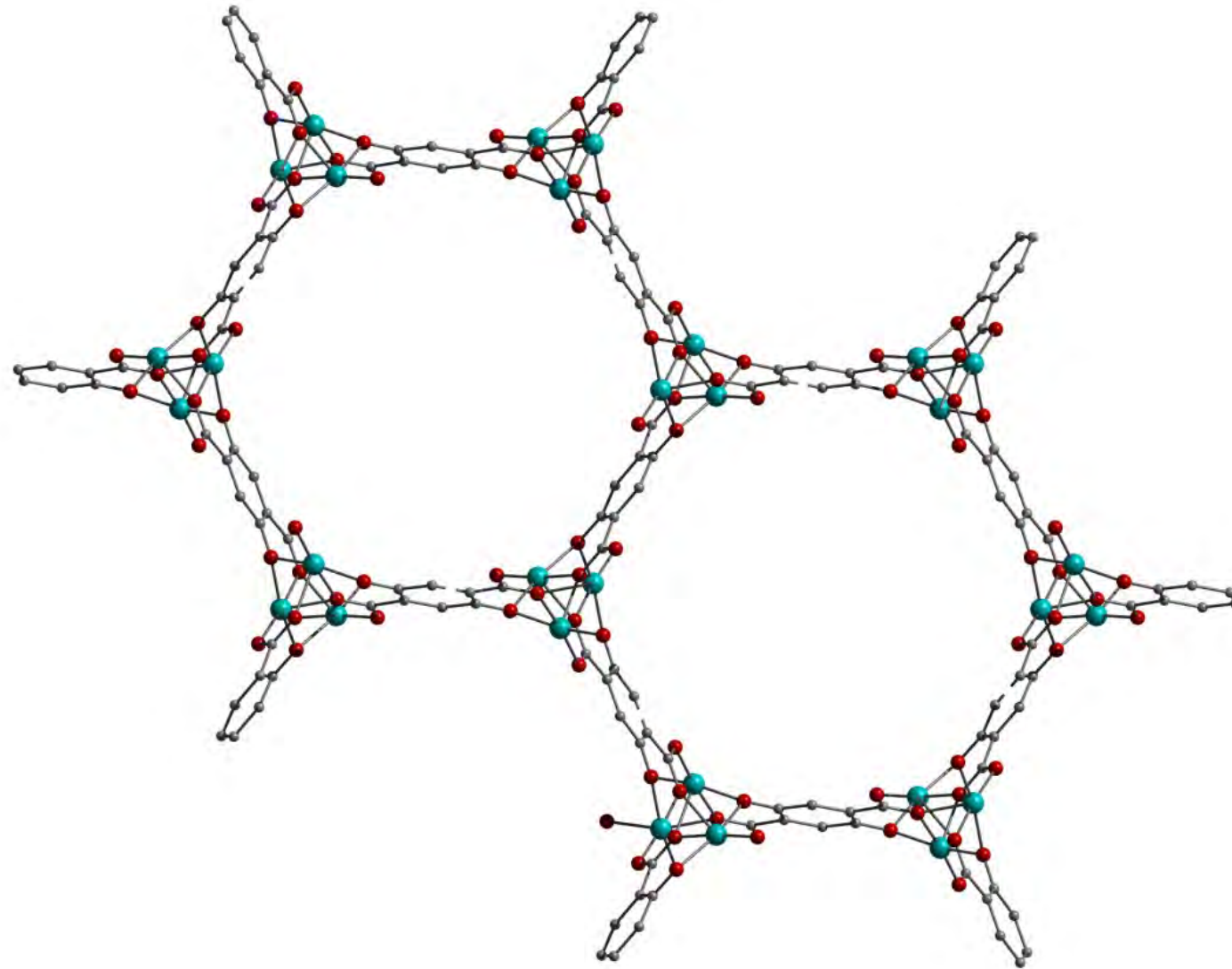

NO absorbed

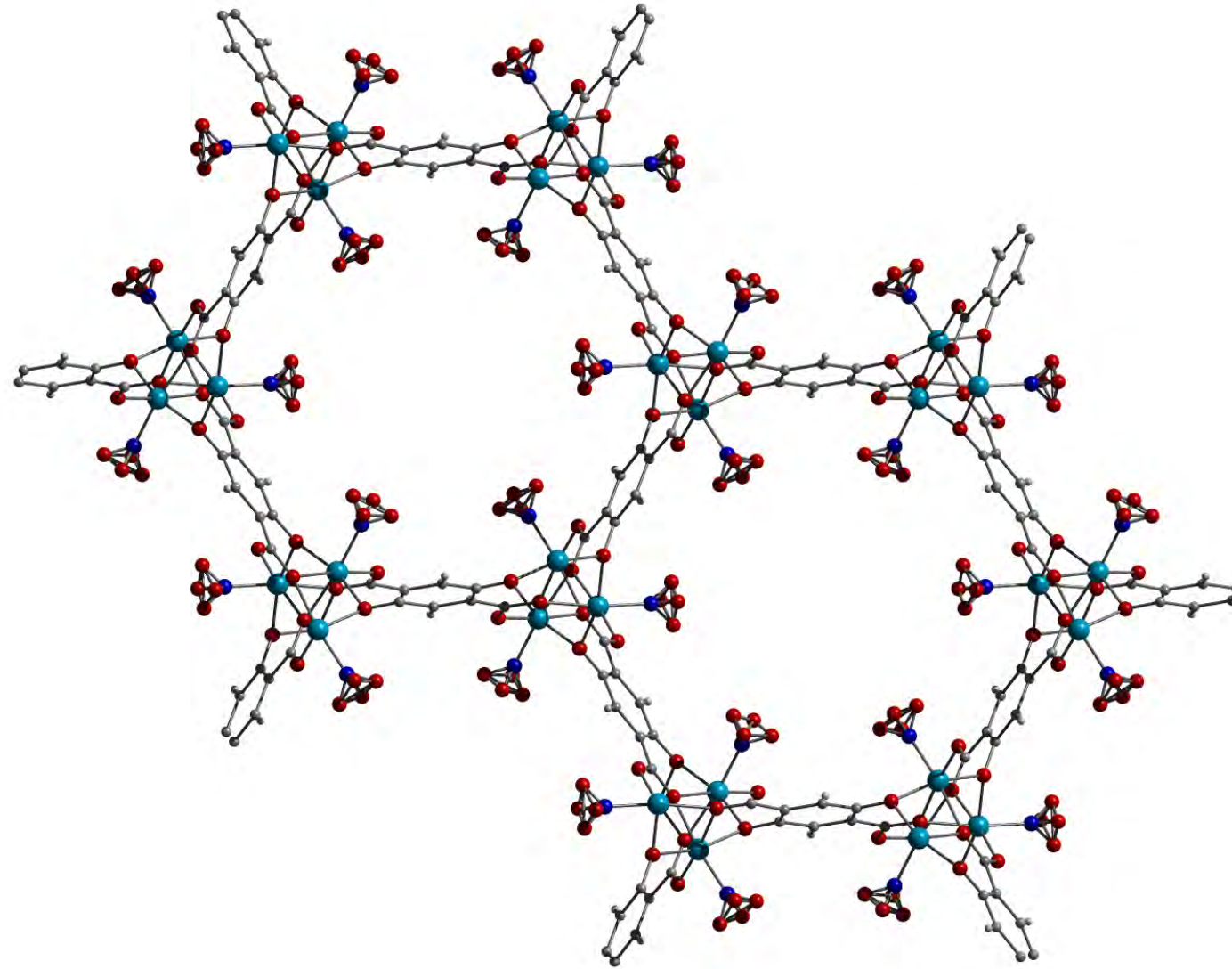

SO₂ absorbed

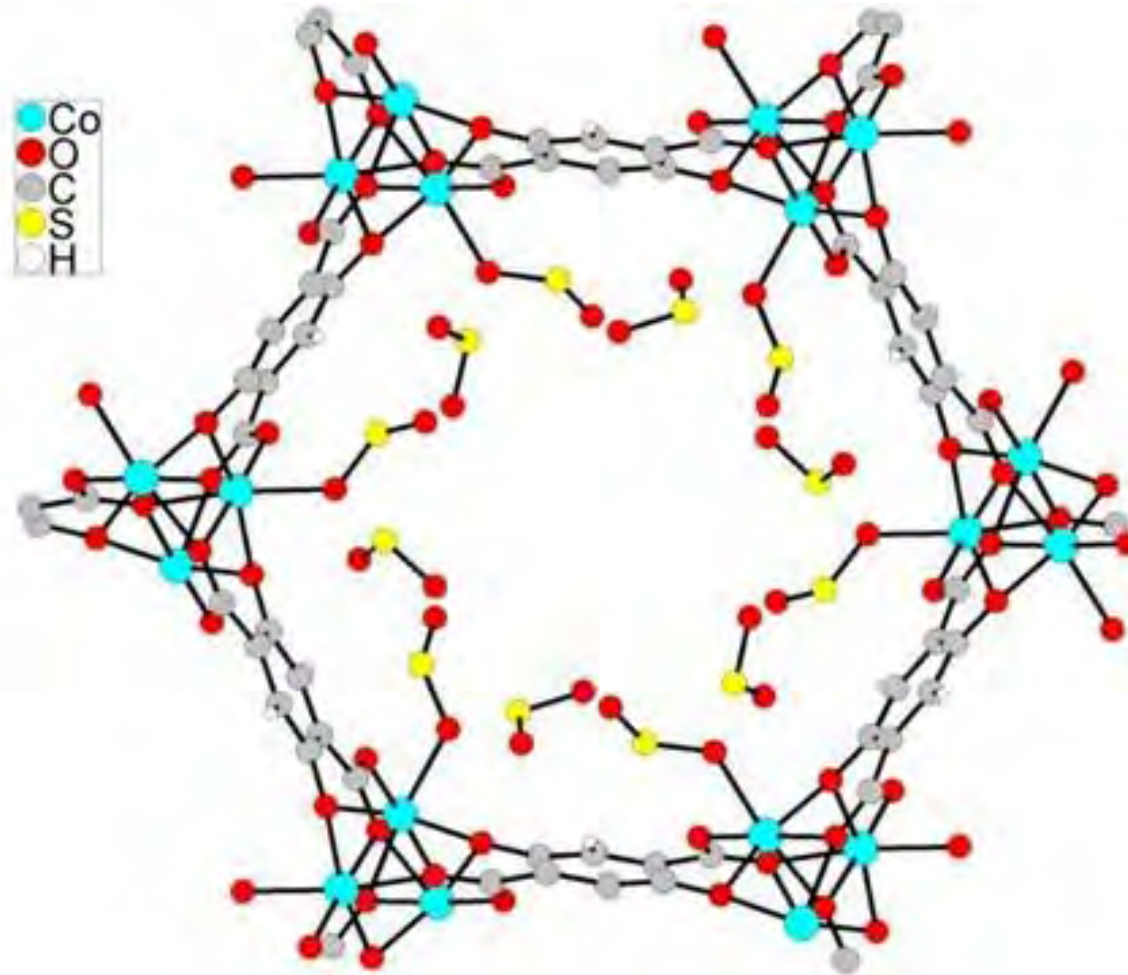

High Pressure with Diamond Anvil Cells

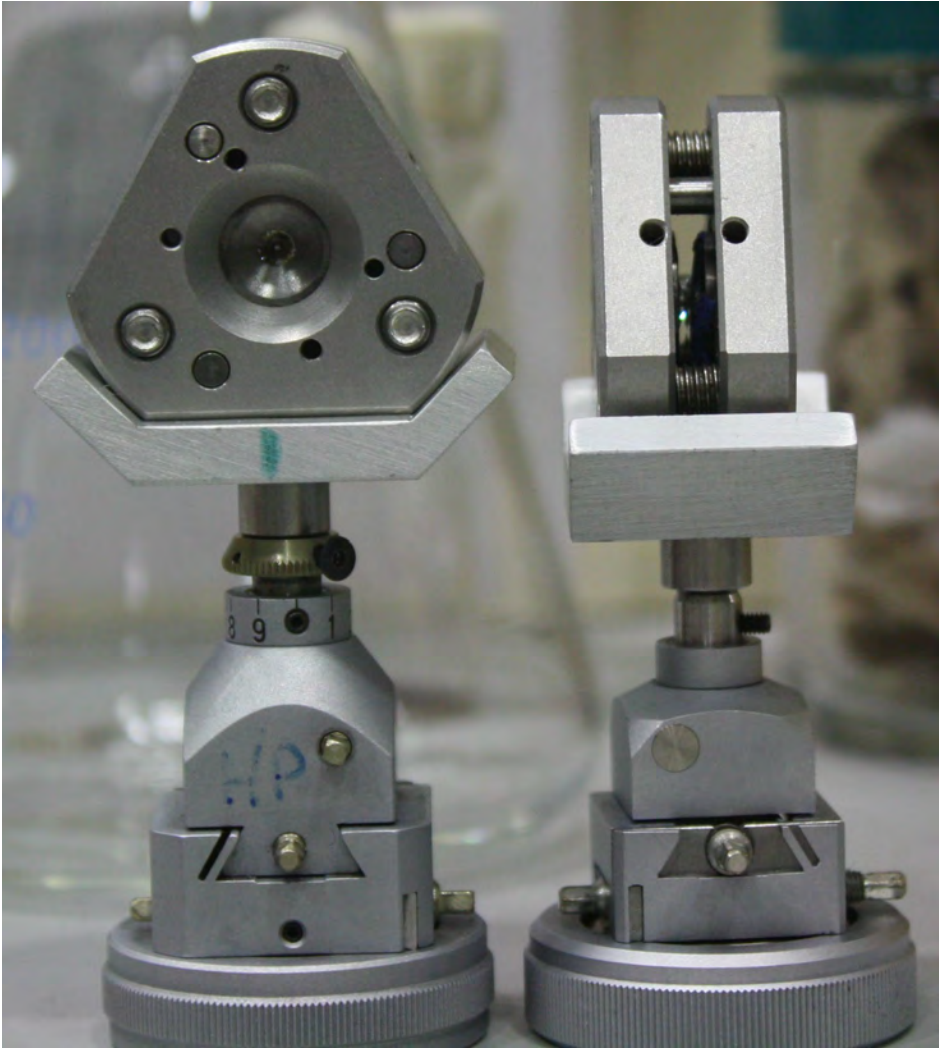
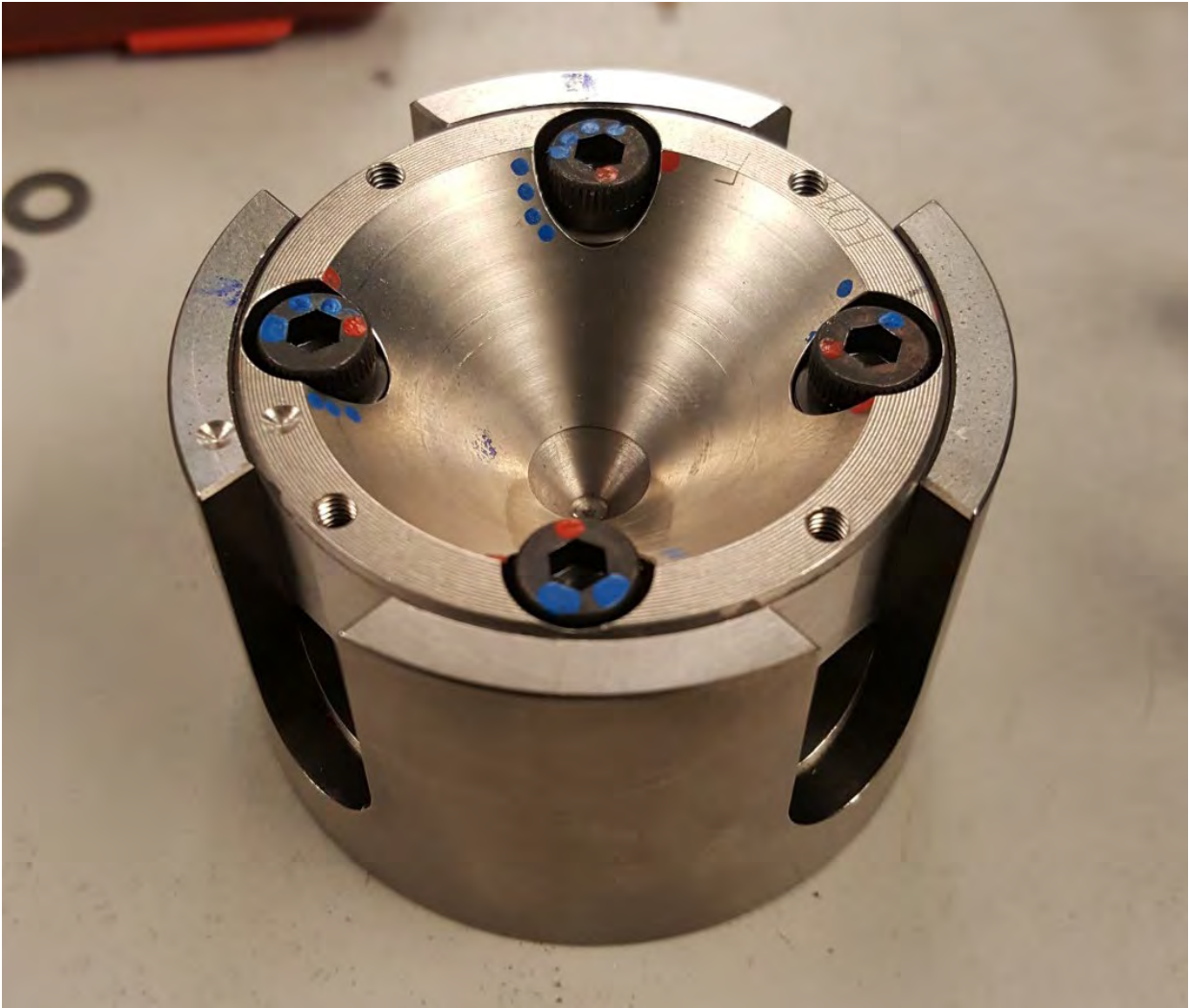

Why High Pressure?

“Pressure is highly efficient for generating phase transitions and new phases, for triggering new chemical reactions, conformational and structural transformations of molecules, polymerization, polymorphism and determining structure–property relations which are of interest to chemists and physicists.”

Exploring the Deep Earth...

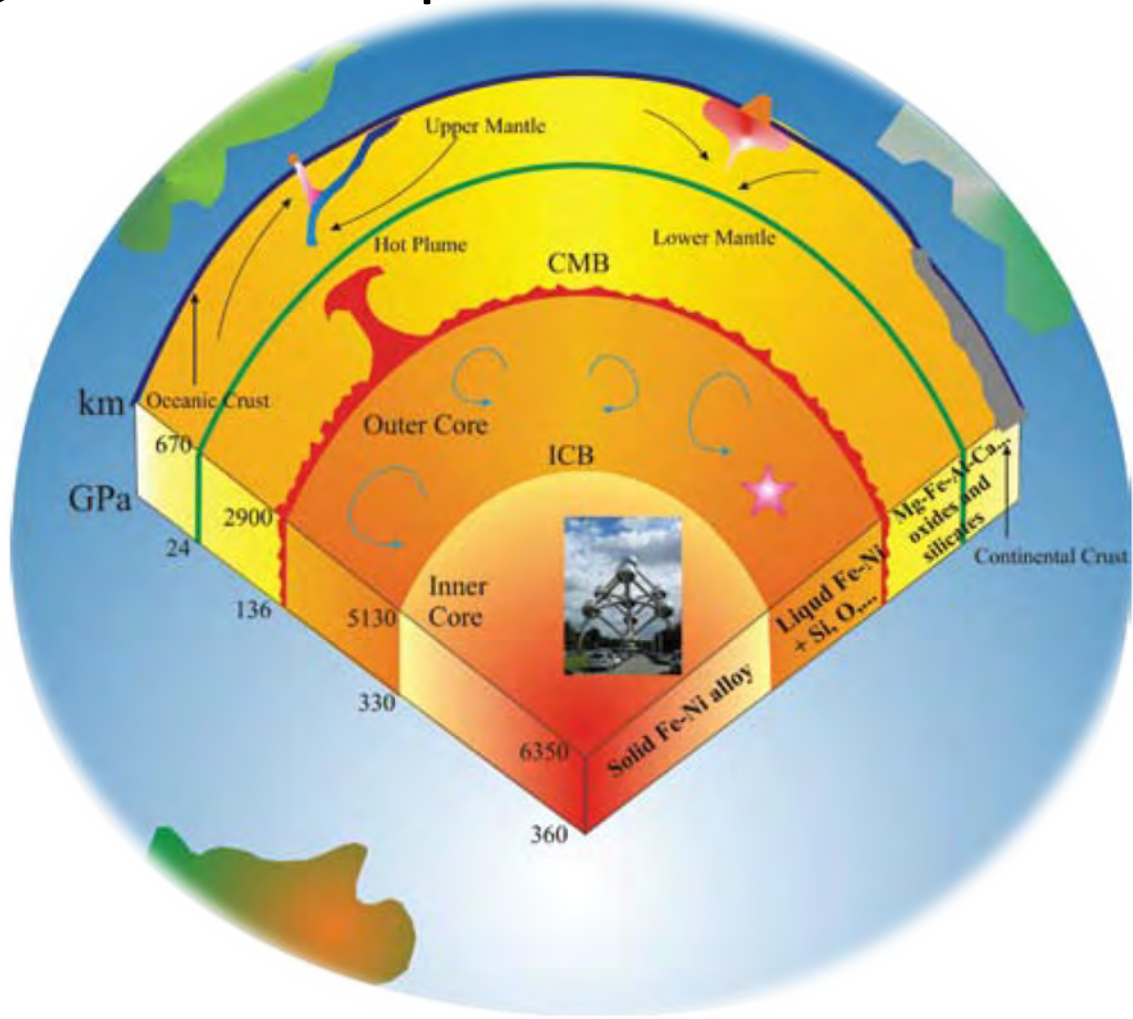

...Without Any Digging

Deep Earth Pressures!



1 gigapascal (Gpa) = 145038 psi

One Elephant on a
pushpin = 50GPa



Deep Earth Pressures!



Depth of the earth vs. Pressure

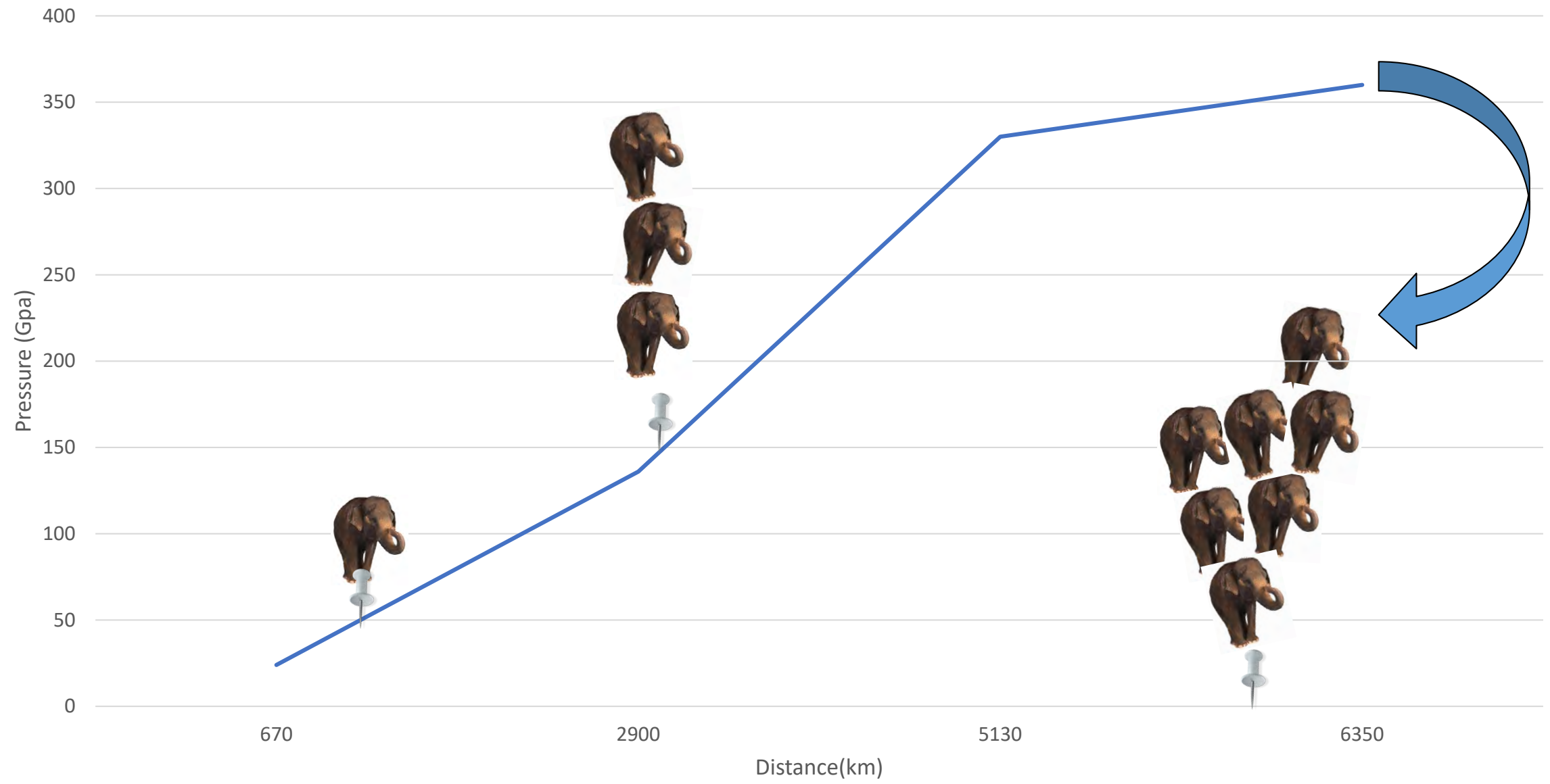



Luckily I'm usually doing chemistry...

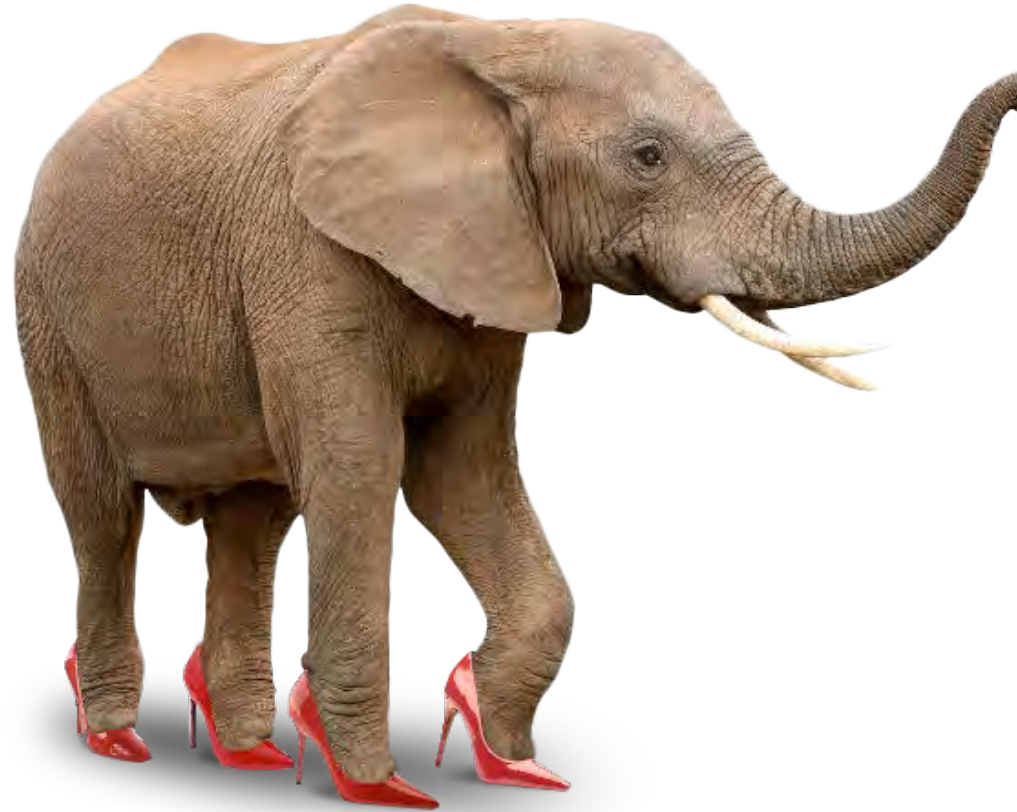

Thanks to Helen Maynard-Casely(ANSTO) for this image!

A Diamond Anvil Cell

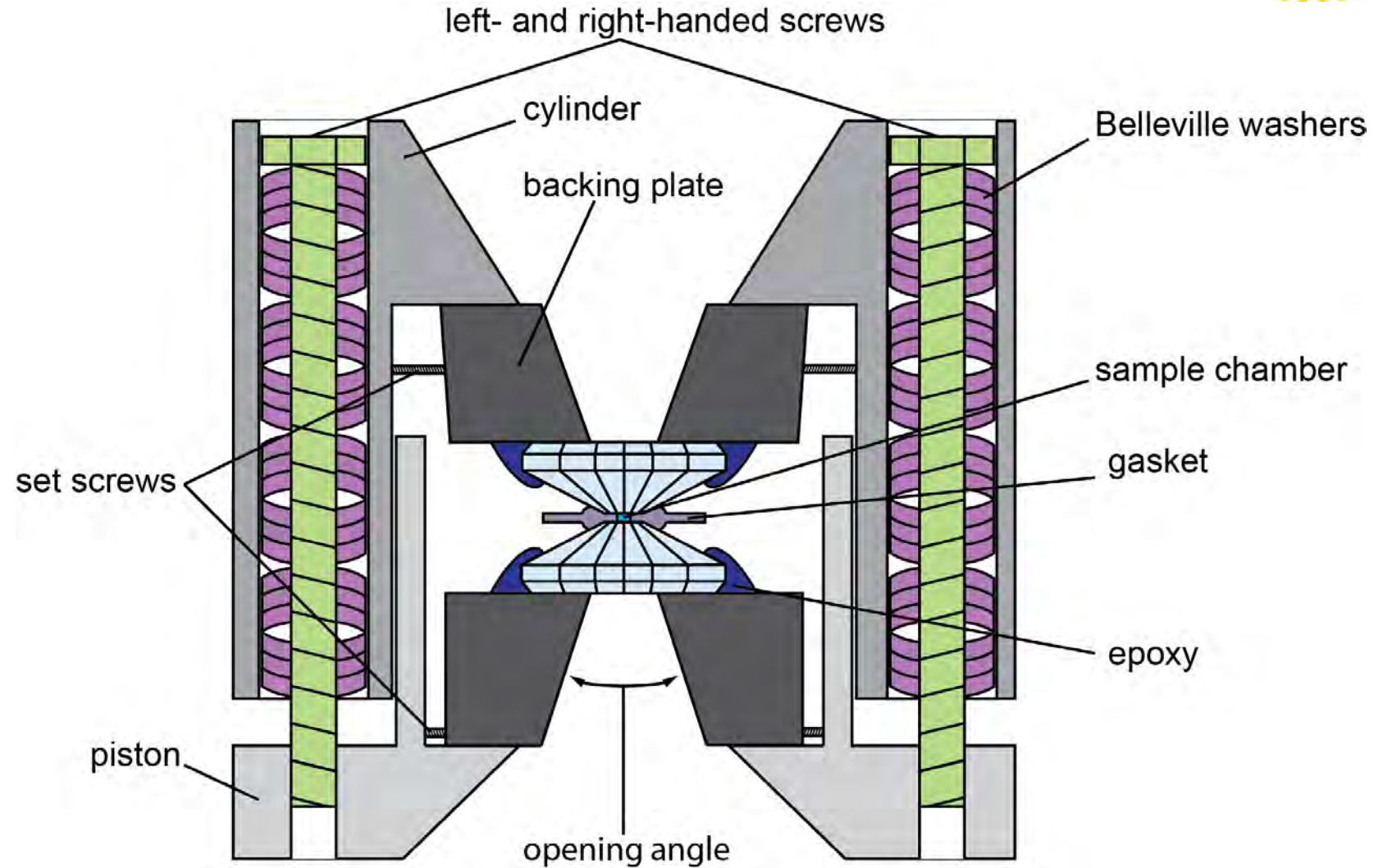
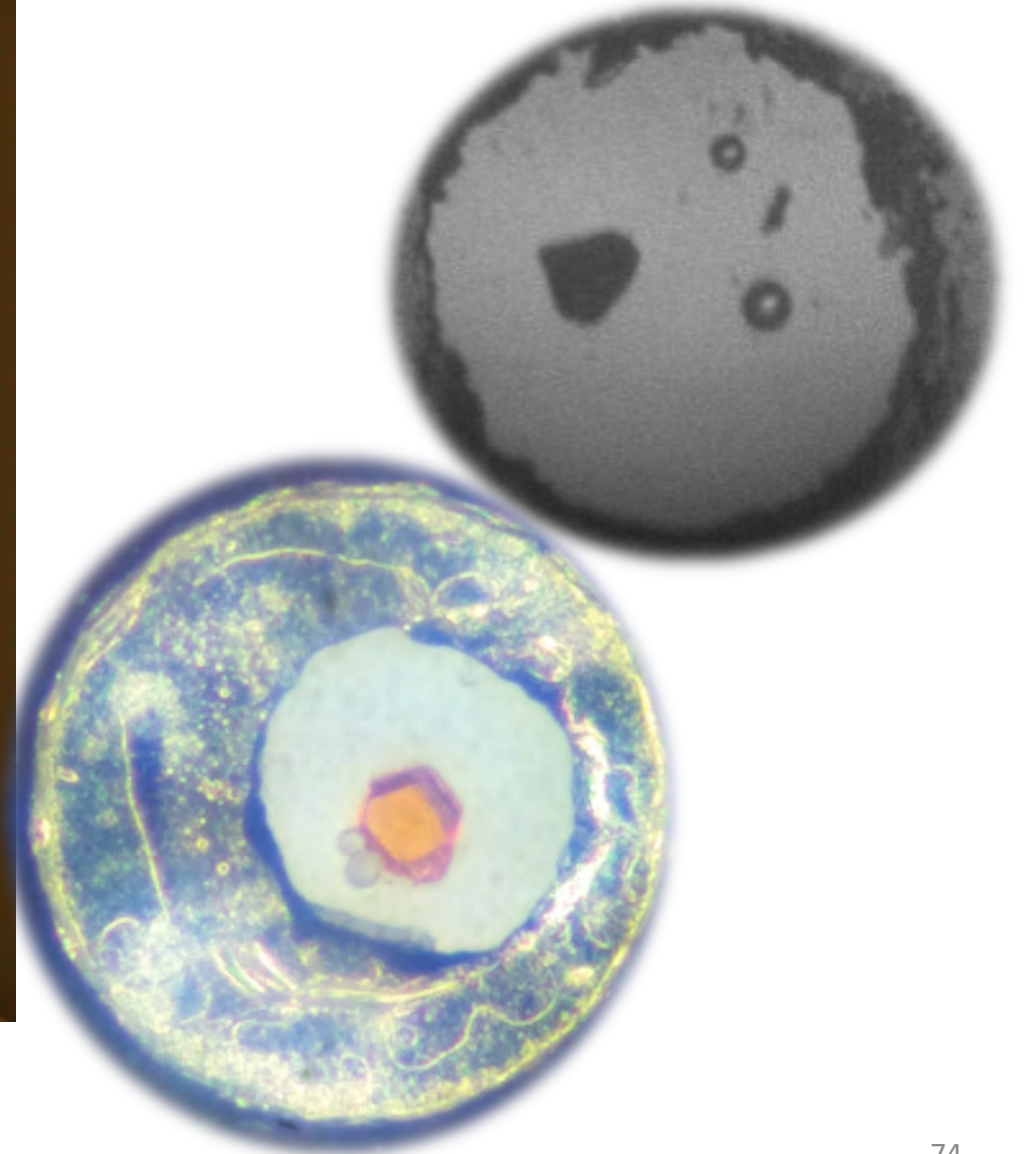
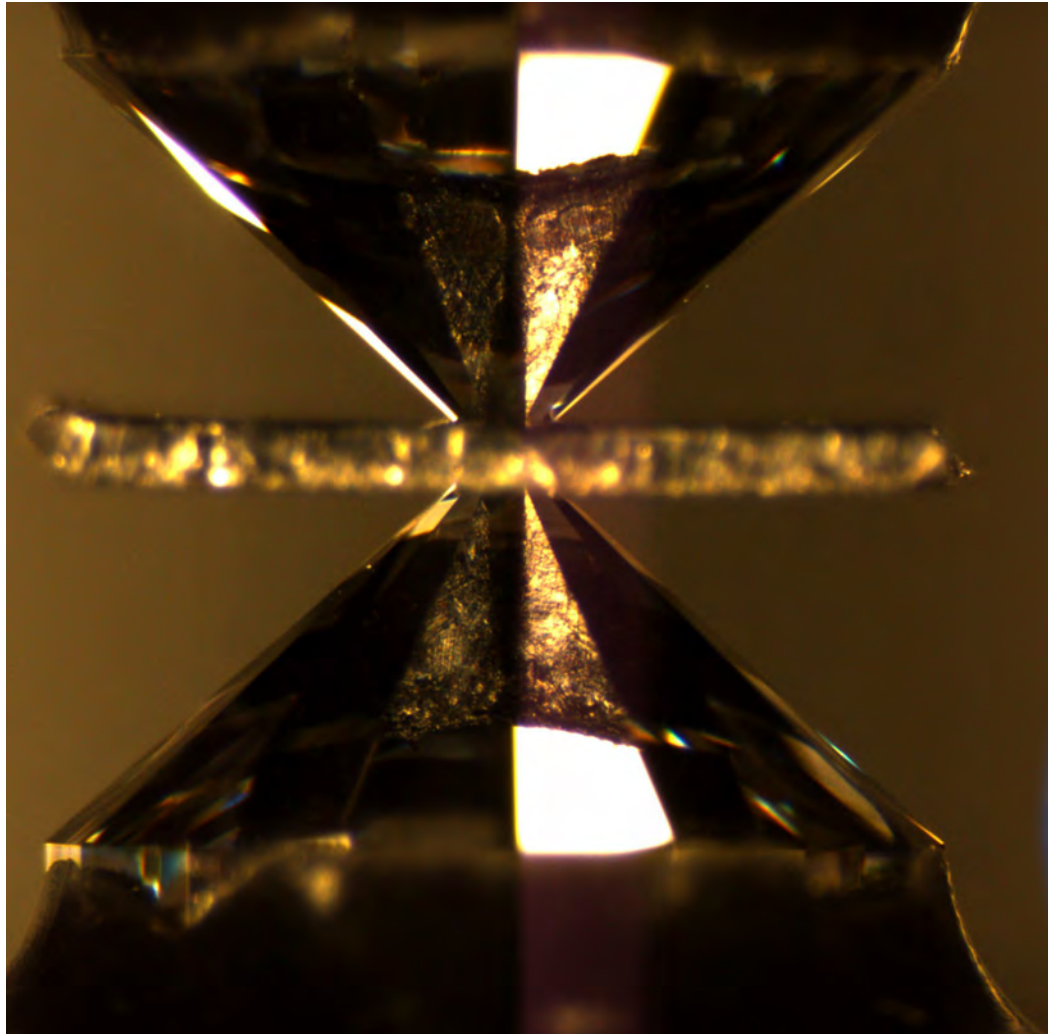

Image by Camelia Stan, LLNL

Diamond Anvil Cell (DAC)



Extreme Close-Up



DIAMOND

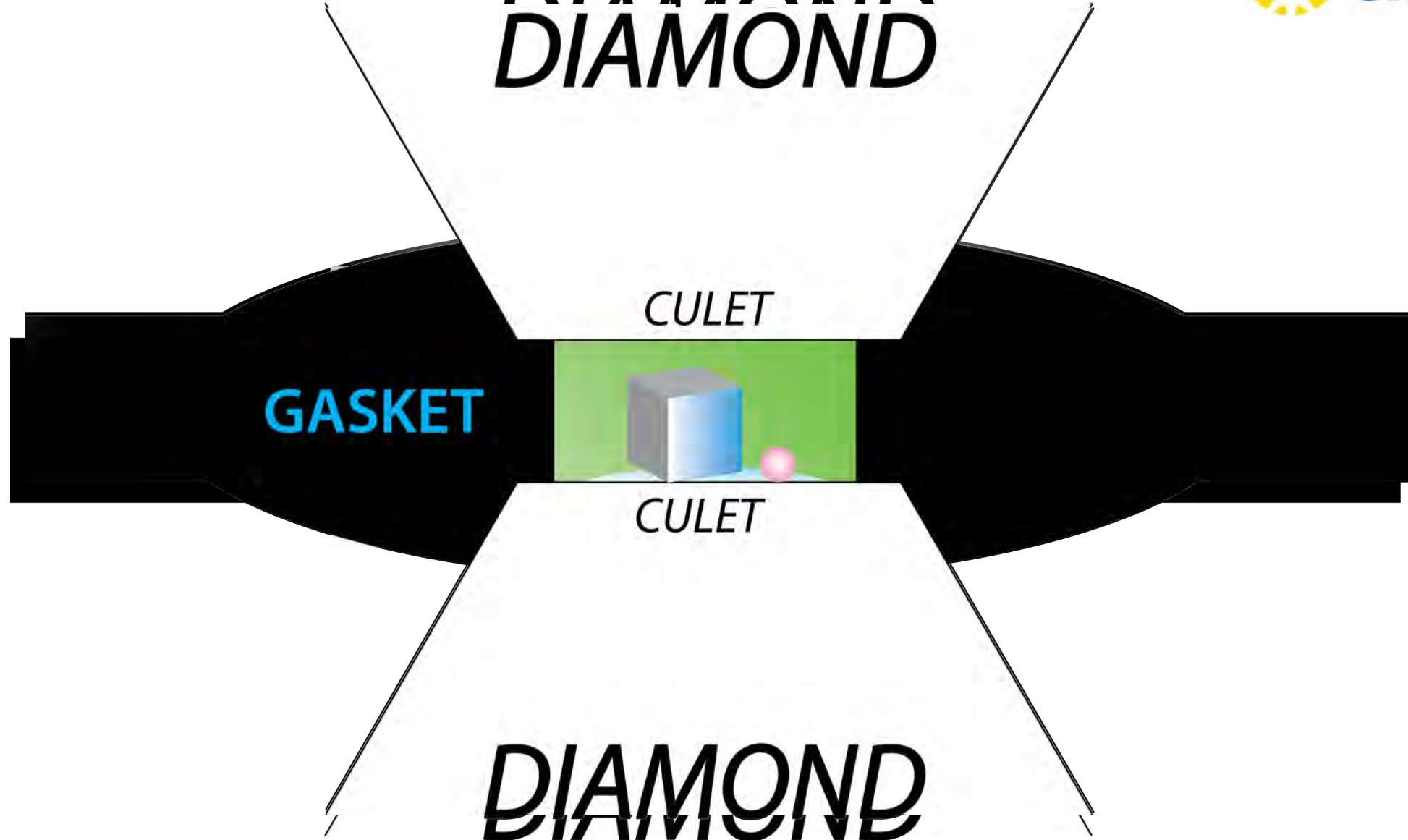

GASKET

CULET

CULET

DIAMOND



Spin Crossover at Pressure

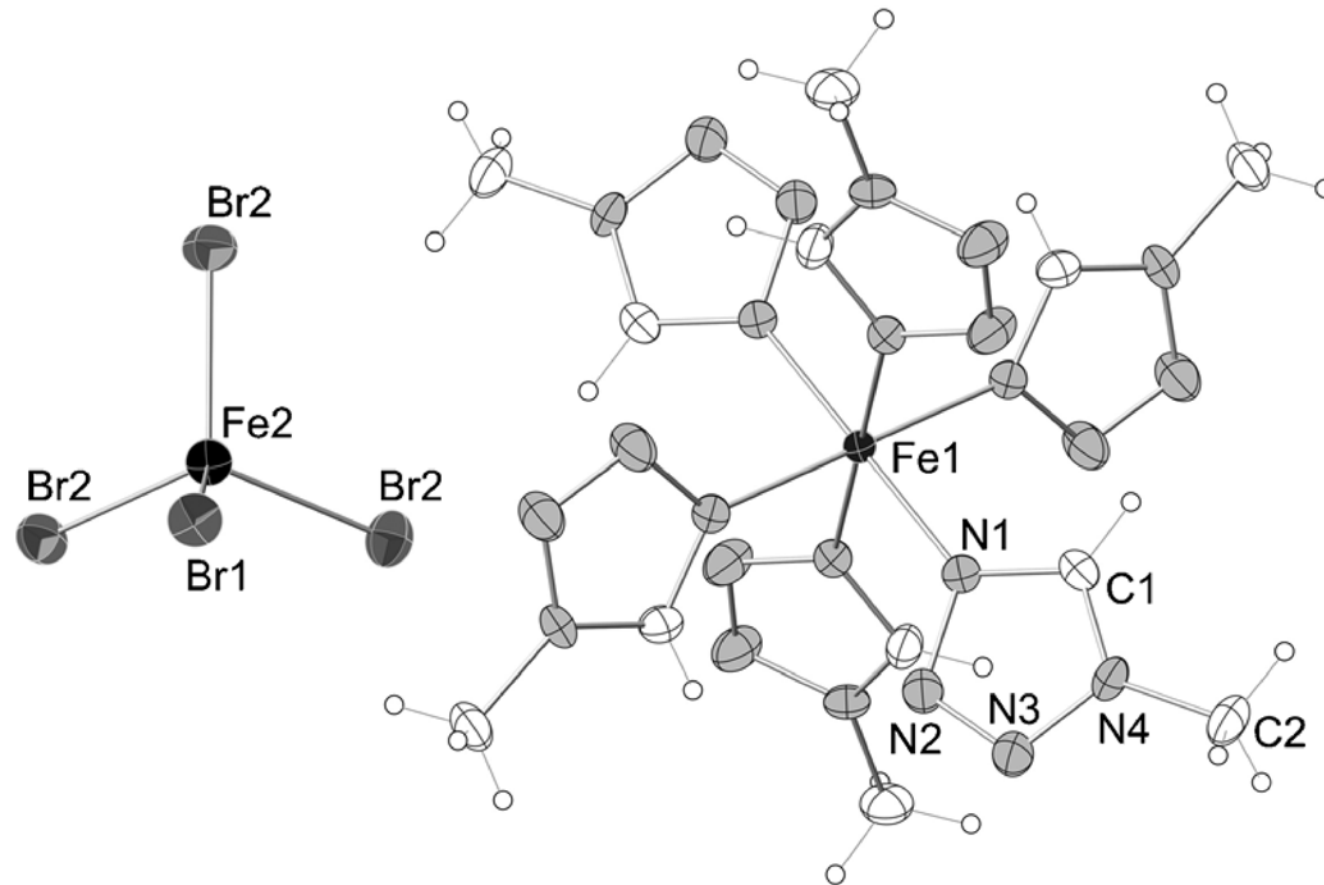

Alberto Rodriguez-Velamazán, J. *et al*; A Multifunctional Magnetic Material under Pressure. *Chemistry-a European Journal* **2014**, *20* (26), 7956-7961



Pb Halide Perovskites at Pressure

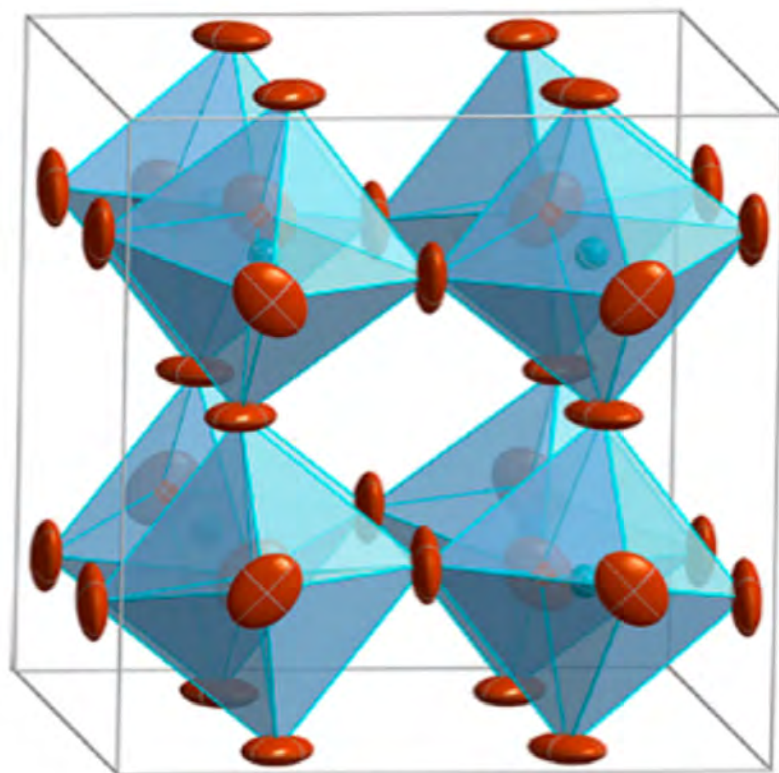

$P = 1.7 \text{ GPa}$

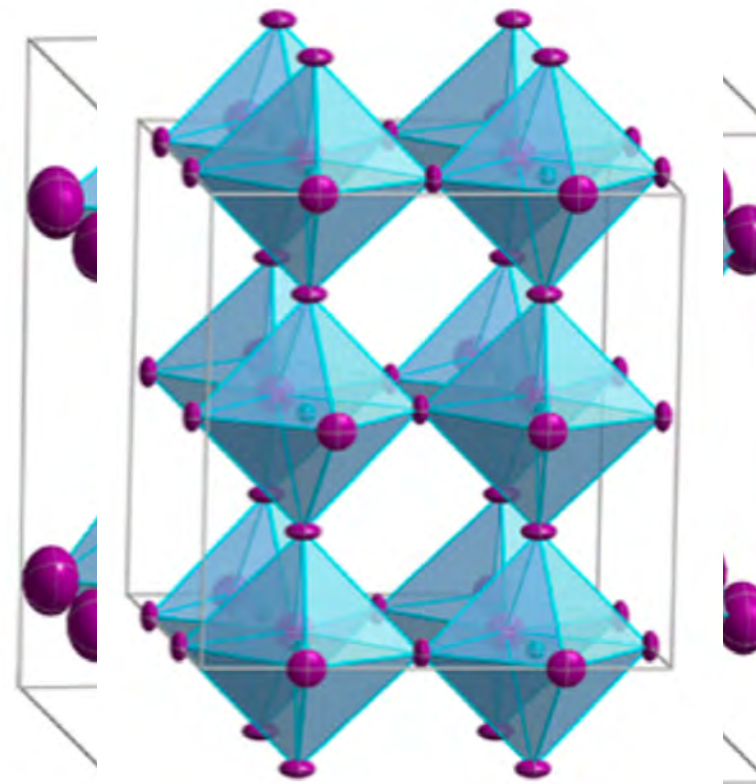

$P = \text{ambient}$

Jaffe, A. *et al*; High-Pressure Single-Crystal Structures of 3D Lead-Halide Hybrid Perovskites and Pressure Effects on their Electronic and Optical Properties. *ACS Central Science* **2016**, 2 (4), 201-209.

Retrofitting a MOF

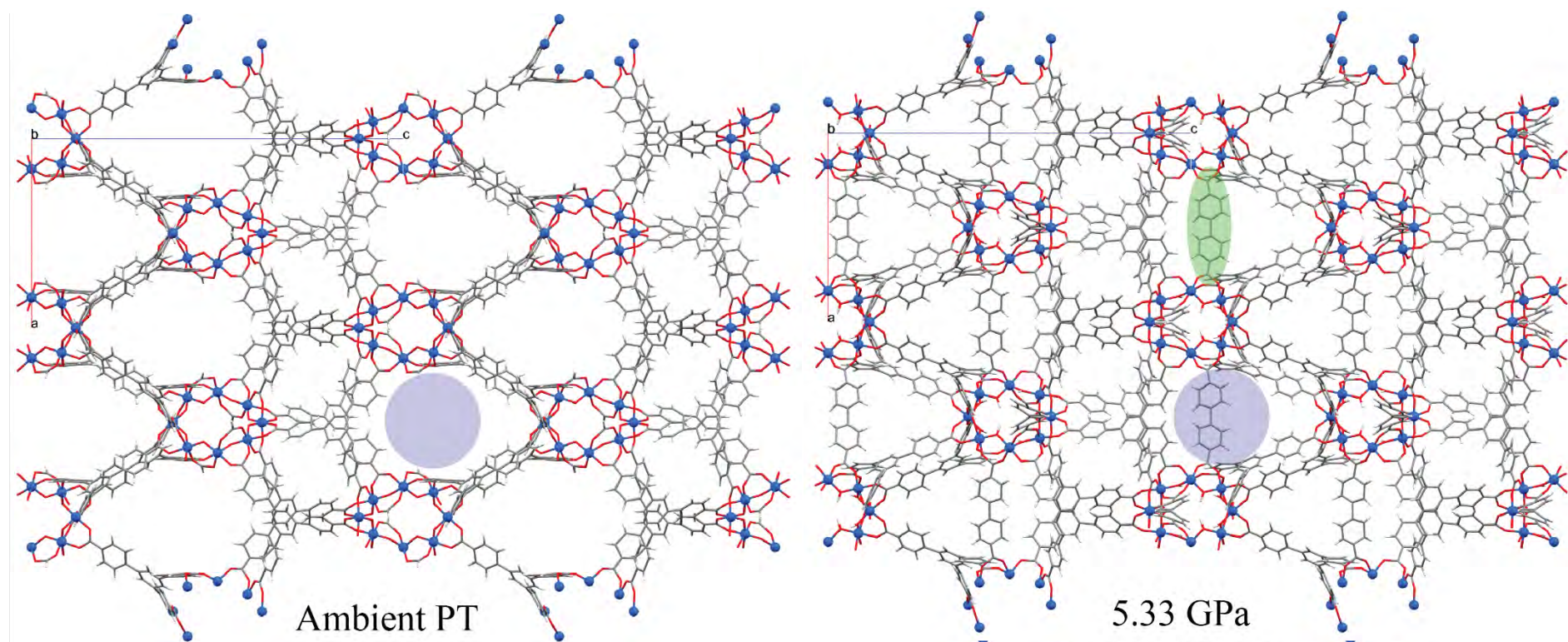

Kapustin, E. A. *et al*; Molecular Retrofitting Adapts a Metal–Organic Framework to Extreme Pressure. *ACS Central Science* **2017**, 3 (6), 662-667.

Why Synchrotrons?



- In situ experiments usually produce the degradation of a crystal, and most are more successful with small crystals.
- Poorly diffracting crystals need as much intensity as they can take.
- In both cases, a synchrotron offers orders of magnitude more flux, which means a better chance of success.



welcometrust



Science & Technology
Facilities Council



The Advanced Light Source is supported by the Director, Office of Science, Office of Basic Energy Sciences, of the U.S. Department of Energy under Contract No. DE-AC02-05CH11231

COMPRES, the Consortium for Material Properties Research in Earth Sciences, is supported under NSF Cooperative Agreement EAR 11-57758.