

23 JUNE 2019

LIGHTING THE WAY UTILIZING ULTRABRIGHT X-RAYS: THE ADVANCED PHOTON SOURCE

STEPHEN STREIFFER

DIRECTOR, ADVANCED PHOTON SOURCE

ASSOCIATE LABORATORY DIRECTOR, PHOTON SCIENCES



AGENDA

- Introduction to storage ring light sources
- Introduction to the Advanced Photon Source
- Science Examples
- Upgrading the Advanced Photon Source

TUBE SOURCE AND BRAGG'S LAW

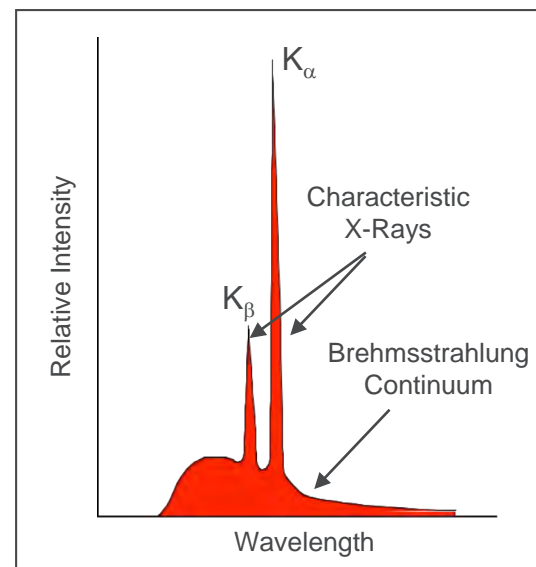
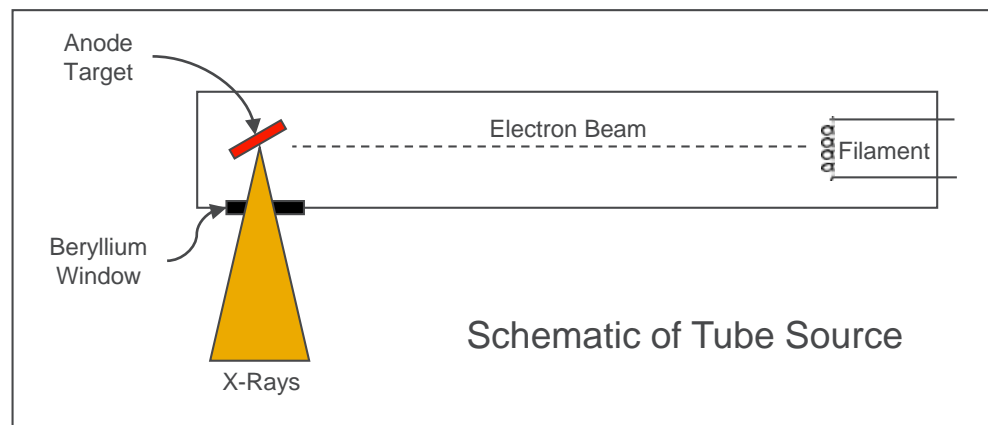

TUBE SOURCE AND BRAGG'S LAW

Bragg's Law

$$n\lambda = 2d\sin\theta$$

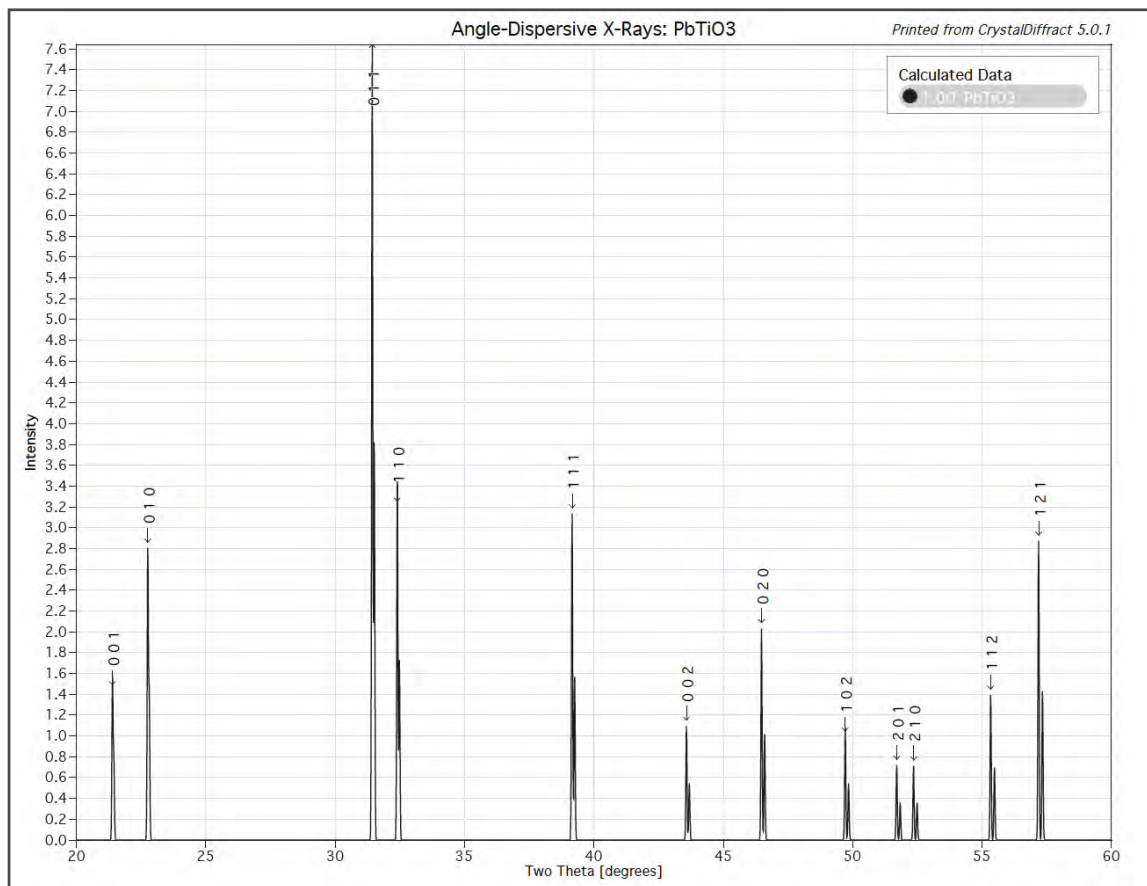

WHY USE A SYNCHROTRON X-RAY SOURCE?

Synchrotron Radiation (SR) -
radiation from the acceleration
of a charged particle

$$\text{Brightness} = \frac{\text{Photons/second}}{(\text{mrad})^2 (\text{mm}^2 \text{ source area}) (0.1\% \text{ bandwidth})}$$

beam collimation

size of beam source

monochromaticity

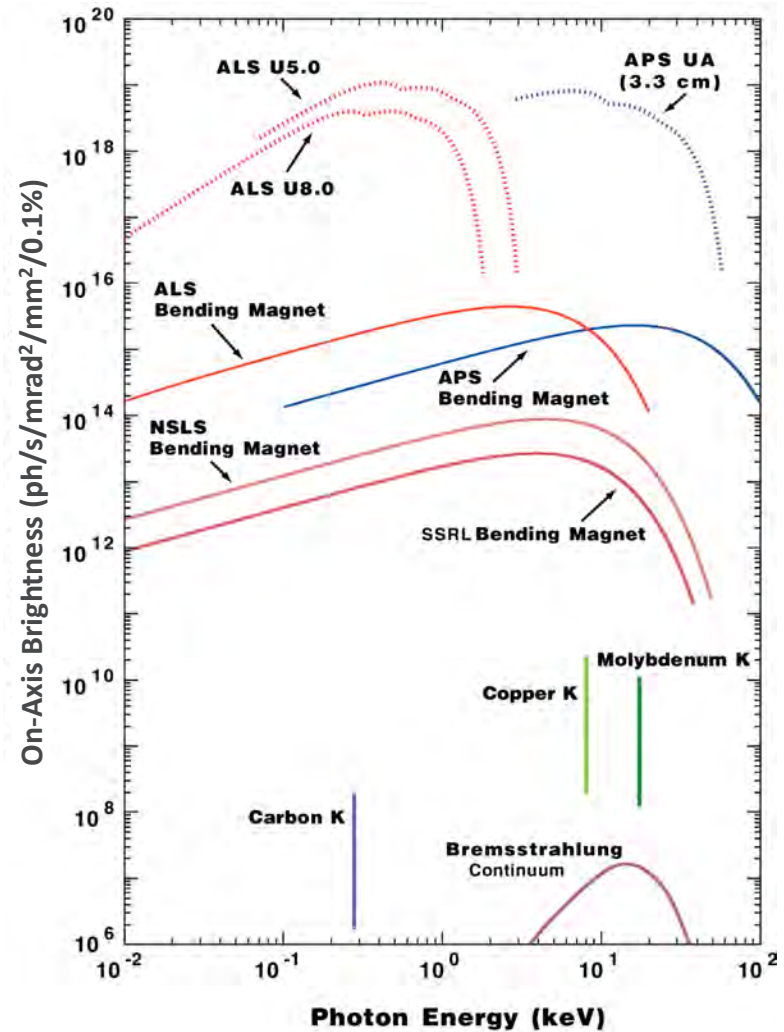

$$\lambda[\text{\AA}] = 12.4 / E[\text{keV}]$$

10.97

WHY USE A SYNCHROTRON X-RAY SOURCE?

- **High brightness:** synchrotron light is extremely intense and highly collimated.
- **Coherence:** synchrotron x-ray wavefronts have a high degree of order^[L]_[SEP]
- **Wide energy spectrum:** synchrotron light is emitted with energies ranging from the infrared to hard, energetic (short wavelength) x-rays^[L]_[SEP]
- **Tunable:** through sophisticated monochromators and insertion devices it is possible to obtain an intense beam of any selected wavelength^[L]_[SEP]
- **Highly polarized:** the synchrotron emits highly polarized radiation, which can be linear, circular or elliptical^[L]_[SEP]
- **Emitted in very short pulses:** pulses emitted are typically less than a nanosecond (a billionth of a second)

HISTORY OF SYNCHROTRONS

- Accelerator-based synchrotron light was seen for the first time at the General Electric Research Laboratory in the USA in 1947
 - Considered a nuisance because it caused the accelerated particles to lose energy
- 1960's: First Generation (CHESS and SSRL)
 - Synchrotron light recognized in the 1960s as being useful as a research tool
 - Parasitic operation on synchrotron colliders
- 1970's: Second Generation (e.g. NSLS)
 - Storage rings designed for and dedicated to the production of synchrotron radiation, dedication of time from high-energy-physics facilities
 - Realization that higher brightness (as opposed to flux) could be realized with better sources (i.e. the way the electron beam is circulated in the storage ring) and using dedicated magnet assemblies (insertion devices)
- 1990's: Third Generation (ALS, APS, NSLS II)
 - New generation of storage rings with a lower emittance (product of beam size and divergence) and long straight sections for undulators, that permit achieving even higher brightness, and with it a considerable degree of spatial coherence
- For more detail, see Arthur L. Robinson, http://xdb.lbl.gov/Section2/Sec_2-2.html
- See also www.lightsources.org

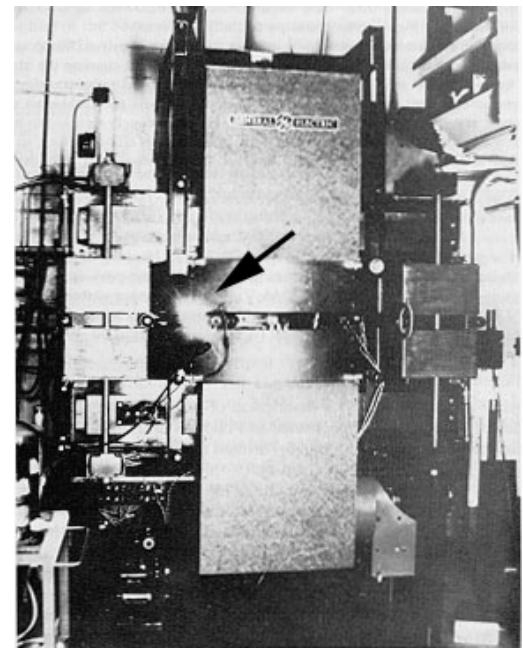

*Synchrotron light from the
70-MeV electron synchrotron at GE*

FROM SYNCHROTRONS TO STORAGE RINGS

THE REVIEW OF SCIENTIFIC INSTRUMENTS

Letters to the Editor

Prompt publication of brief reports of NEW ideas in measurement and instrumentation or comments on papers appearing in this Journal may be secured by addressing them to this department. No proof will be sent to the authors. Communications should not exceed 500 words in length. The Board of Editors does not hold itself responsible for the opinions expressed by the correspondents.

Use of Synchrotron Orbit-Radiation in X-Ray Physics*

L. G. PARRATT

Cornell University, Ithaca, New York

(Received December 1, 1958)

IT is well known by now that intense x-radiation is emitted by the centripetally accelerated electrons in the orbit of a high-energy synchrotron.¹ Comparison is made here of the prospective usefulness of this radiation in the range of wavelengths 0.1 to 20 Å with the x-rays obtainable from a conventional x-ray tube.

I. Calculations of the spectral distribution for three typical synchrotron energies and orbit radii are shown in Fig. 1.^{2,3} The spectral power is shown averaged over one-half of an acceleration cycle in which the electron energy is taken as proportional to the square of a sinusoid.⁴ The power is expressed in ergs per second per 4π solid angle per x unit per electron, and must be trimmed

- Synchrotrons were first used as sources of SR. However, the particles' constantly changing energy was not attractive and the advent of storage rings provided a far more attractive source.
- We now use the name synchrotron radiation to describe radiation that is emitted from charged particles traveling at relativistic speeds, regardless of the accelerating mechanism and shape of the trajectory.
- Although synchrotron radiation can cover the entire electromagnetic spectrum, we are interested in radiation in the x-ray regime.

WHAT IS A SYNCHROTRON?

Acceleration of a charged particle causes it to give off energy as photons

- Electrons (or positrons) are accelerated to almost the speed of light by a linear accelerator (linac) and booster ring. They are then transferred to an outer storage ring.
- The electrons are confined to the “circular” orbit by a series of bending magnets separated by straight sections.

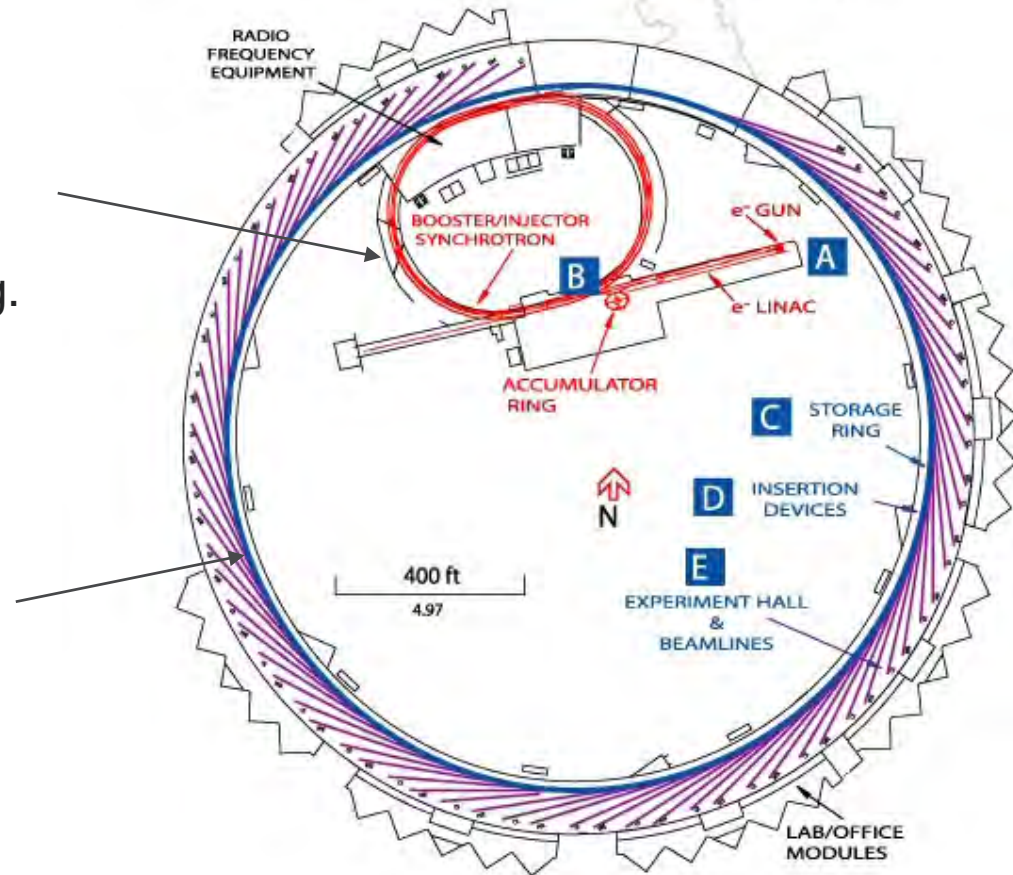

WHAT IS A SYNCHROTRON?

- As the electrons are deflected through the magnetic field created by the bending magnets, they give off electromagnetic radiation, so that at each bending magnet a beam of synchrotron light is produced.
- Electrons passing through “insertion devices” in the straight sections of the ring give off an extremely intense beam of light
- Energy is added back to the electron beam using rf cavities

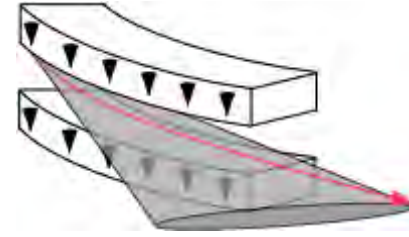

Bending Magnet: Deflection of the electron path yields a fan of radiation with a broad energy spectrum

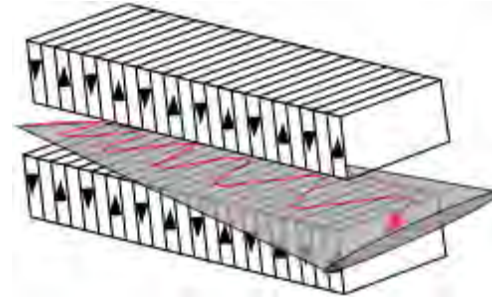

Wiggler: Intensities add with the number of wiggles

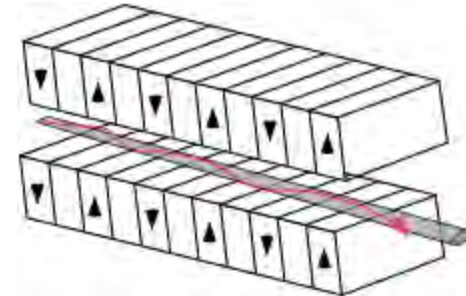

Undulator: Radiation from each undulation interferes constructively, yielding a narrow energy spectrum with high brightness

TYPICAL STORAGE RING SECTOR

One Sector of the Advanced Photon Source Storage Ring

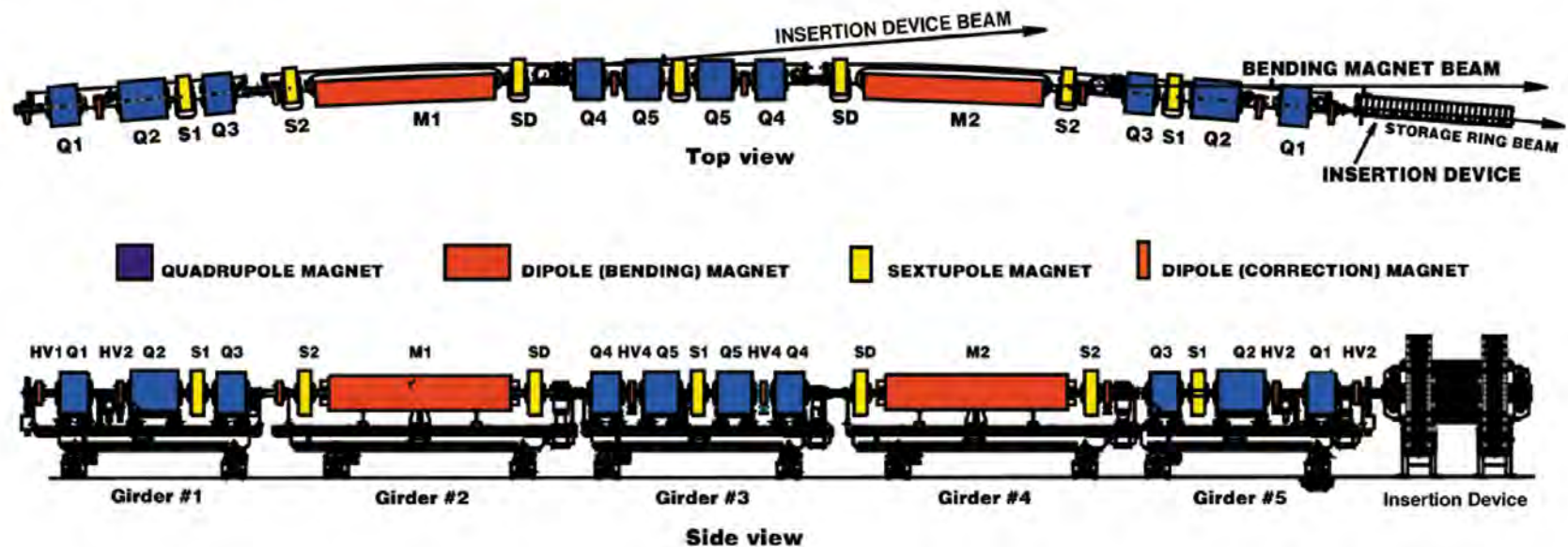

Magnets and vacuum chambers are mounted on girders, which are aligned in the storage ring tunnel to a tolerance of ± 0.1 mm.

TYPICAL STORAGE RING SECTOR



UNDULATOR INSERTION DEVICES



TYPES OF SYNCHROTRON X-RAY METHODS

- Scattering and Diffraction
 - Very high resolution
 - Penetration into sample can be tuned by the incidence angle
 - Tunable wavelength: anomalous scattering - element specific
 - High energy - penetrating
 - Dynamical scattering
 - Small-angle scattering
 - Magnetic scattering
- Spectroscopy
 - Penetration into sample can be tuned by the incidence angle
 - Fluorescence
 - X-ray absorption fine structure
 - Inelastic scattering
- Microscopy and Imaging
- Time-Resolved Measurements

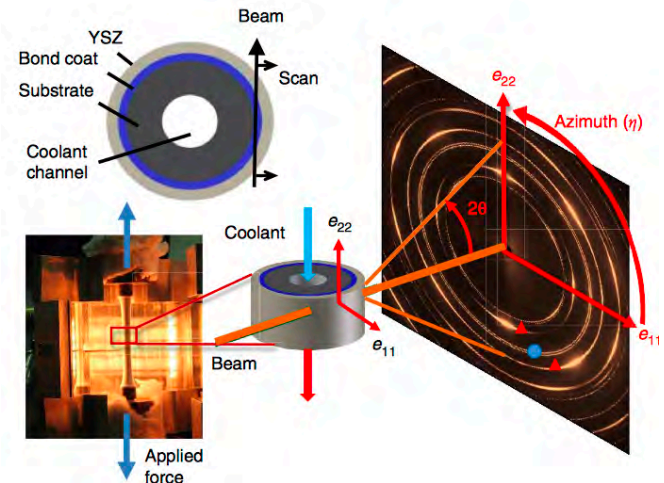

Technology Implications: Accurate lifespan estimates of materials, wider adoption of thermal barrier coatings, increased fuel and energy efficiency for autos, airplanes, boats, energy generation facilities. For example, 1 % increase in operating temperature at a single electric generation facility can save up to \$20 million a year

TYPES OF SYNCHROTRON X-RAY METHODS

- Scattering and Diffraction
 - Very high resolution
 - Penetration into sample can be tuned by the incidence angle
 - Tunable wavelength: anomalous scattering - element specific
 - High energy - penetrating
 - Dynamical scattering
 - Small-angle scattering
 - Magnetic scattering
- Spectroscopy
 - Penetration into sample can be tuned by the incidence angle
 - Fluorescence
 - X-ray absorption fine structure
 - Inelastic scattering
- Microscopy and Imaging
- Time-Resolved Measurements

Growth of Al-rich dendrite in Al-Cu alloy
Cooling rate 1K/min from 550 K
3D tomographic dataset in 1.6 s

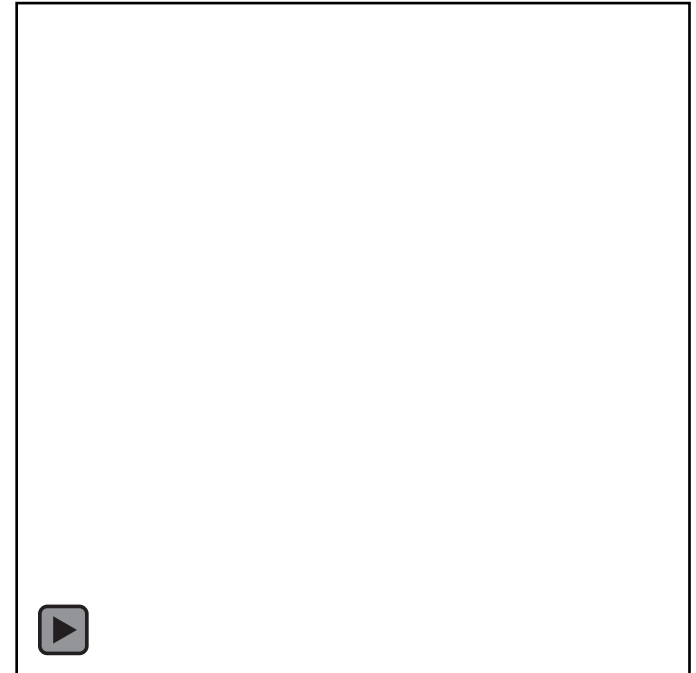

J. W. Gibbs, K. A. Mohan, E. B. Gulsoy, A. J. Shahani, X. Xiao, C. A. Bouman, M. De Graef & P. W. Voorhees, "The Three-Dimensional Morphology of Growing Dendrites,"
Sci. Rep. 5, 11824 (03 July 2015). | DOI: 10.1038/srep11824

HOW TO BUILD A SYNCHROTRON



- Ring radius: Cost is linear with circumference
- Electron beam energy: Sets performance as a function of photon energy (higher is better), but power requirements go up really fast with energy
- Magnets are only so strong, so can steer the electron beam only so much
- Fill current: determines the photon flux, but limited by packing of electrons in the storage ring and how much power you're willing to pay for.
- Storage ring design gives the emittance (size x divergence) of the electron beam
- Emittance sets brightness and coherent flux

Storage Rings and Free-Electron Lasers

Storage Rings



Near continuous sources with high average brightness, wide tunable energy range, and high stability enable:

- Imaging and spatially resolved spectroscopies of complex systems and processes
- Study of systems evolving on hierarchical time and length scales
- Probing intrinsic atomic fluctuations with unclocked correlation spectroscopies
- Balanced flux on sample to follow processes (interact but do not destroy)
- Diverse, highly optimized, multiplexed end stations solving critical problems for a wide range of scientific and technological communities and numerous user groups

Free-Electron Lasers



Pulsed sources with ultra-high peak and average brightness with full spatial coherence enable:

- Resolving ultrafast processes critical for emergent properties, excited-state transient phenomena, bond breaking and formation
- Development and application of non-linear x-ray techniques
- Near-instantaneous snapshots of processes in isolated areas (diffract before destroy)
- A small number of end stations addressing carefully selected, high-profile problems

DOE's Light Source Network

Impact by the Numbers

- ~ 12,000 users each year
- From all 50 states, ~33 countries
- Oversubscribed by factor of 3 or 4
- More than 250 universities
- More than 200 companies, many Fortune 500
- 4 Nobel Prizes



Product breakthroughs:

HIV & cancer drugs, green refrigerants, improved LEDs, green fracking, thin films, industrial batteries, gasoline injector system

Government partnerships:

DOE, NIST, NSF, NIH, NNSA, DOD, NASA

Soft(est) X-Rays

Intermediate Wavelength X-Rays

Hard X-Rays & X-Ray Lasers

Hard(est) X-Rays

ALS

Best for surface chemistry and electronic structure



NSLS-II & SSRL

High flux for diverse range of characterization and exploration



LCLS

Ultrabright X-Ray Laser best for probing ultrafast dynamics in molecules and materials



APS

Best for studies of real materials, systems, and processes in real time under real operating conditions



Each has unique characteristics as well as tailored overlap of certain capabilities, to cover the entire discovery space for a broad user base

ACCELERATOR-BASED RADIATION SOURCES AROUND THE WORLD



Moore's Law for X-ray Source Brightness

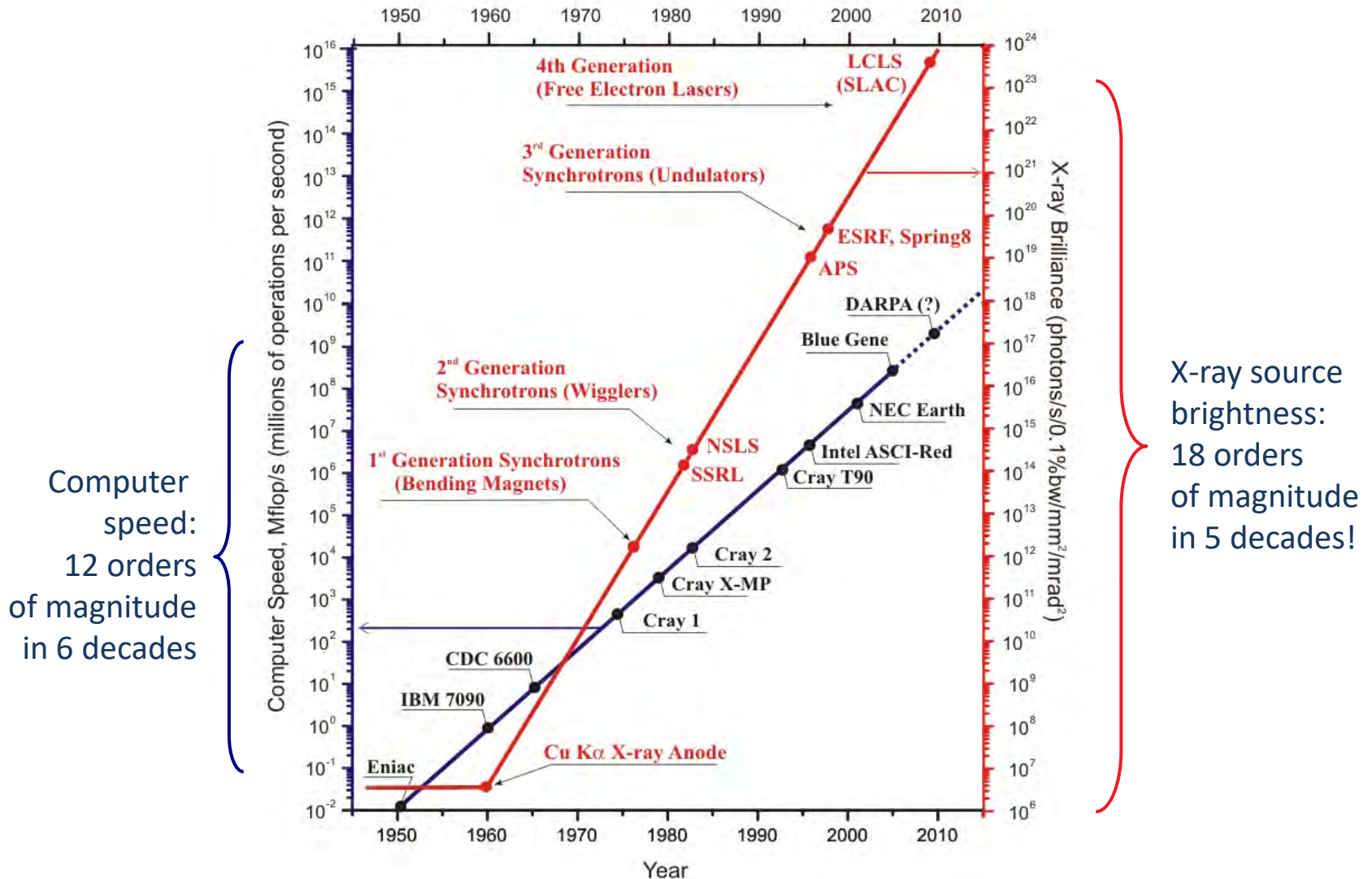

THE ADVANCED PHOTON SOURCE OVERVIEW

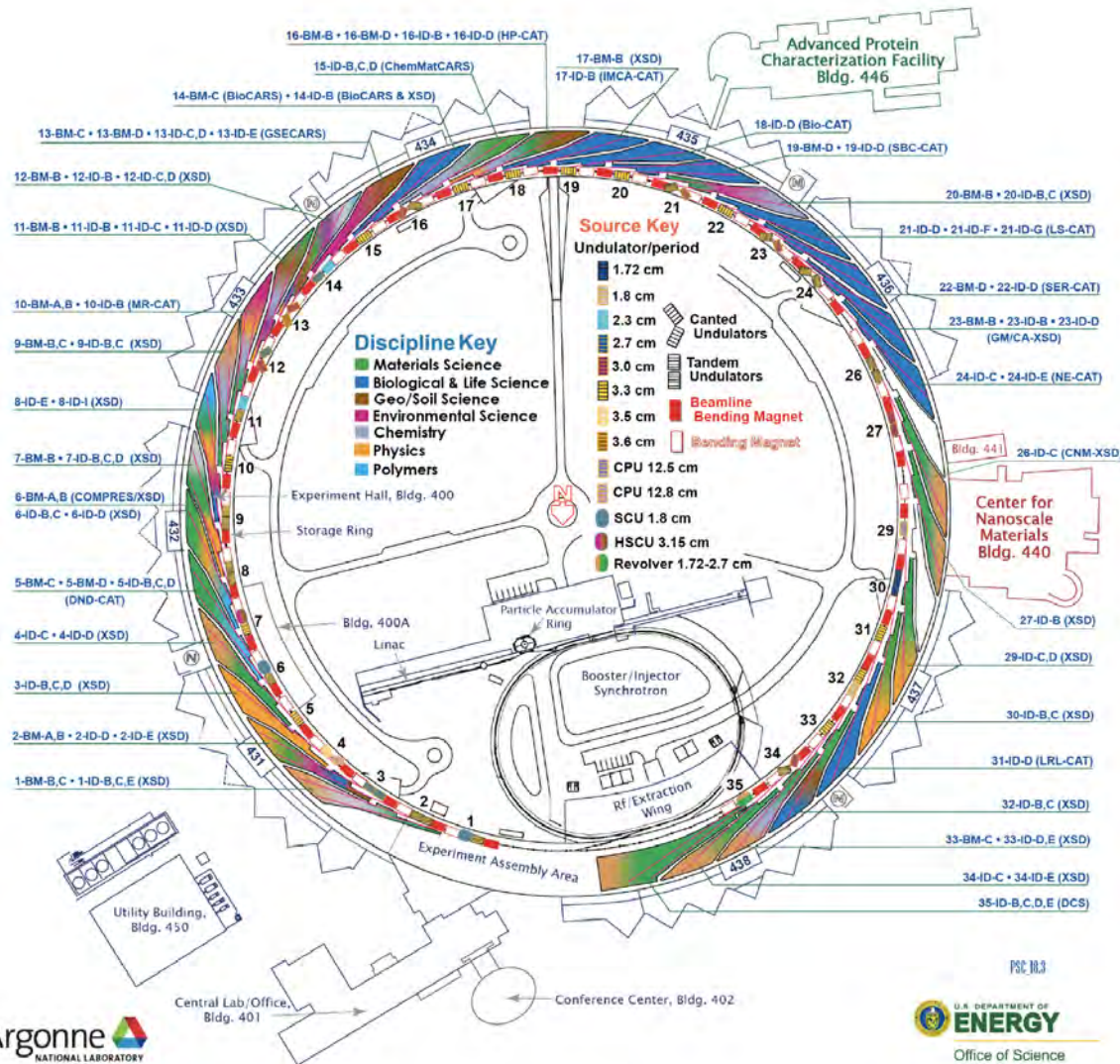

- 68 simultaneously operating endstations
 - 46 undulator beamlines
 - 22 bending magnet beamlines
 - 35 APS-operated with BES funding
 - 33 partner beamlines, principally CATs
- Two sectors (25,28) being developed by APS-U

APS OPERATIONS OVERVIEW

- Commissioned in 1995, first top-up operation in 1999
- 7 GeV light source operating at 102 mA
 - 1104 m circumference
 - 40 sectors, 35 ID straights
 - Effective emittance of 3.1 nm
 - Vertical emittance of 40 pm, 1.3% coupling
- Two fill modes support timing studies
 - 102 mA, 24 bunch mode:
 - 65% of time (~9 h lifetime)
 - 102 mA, hybrid mode
 - 15% of time (~6 h lifetime)
 - Both require top-up
- 102 mA, 324 bunch mode does not require top-up (~60h lifetime)

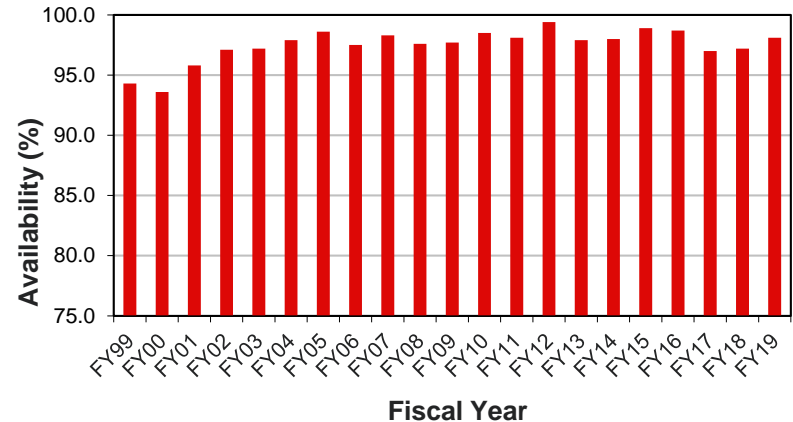

*2 runs
in FY17

Fill patterns

24-bunch (65%): 80 ps (FWHM), 4.25 mA



Hybrid-singlet (15%): 120 ps (FWHM), 16 mA



324-bunch (20%): 50 ps (FWHM), 0.3 mA



SERVING A LARGE, HIGHLY PRODUCTIVE, AND SCIENTIFICALLY DIVERSE USER COMMUNITY

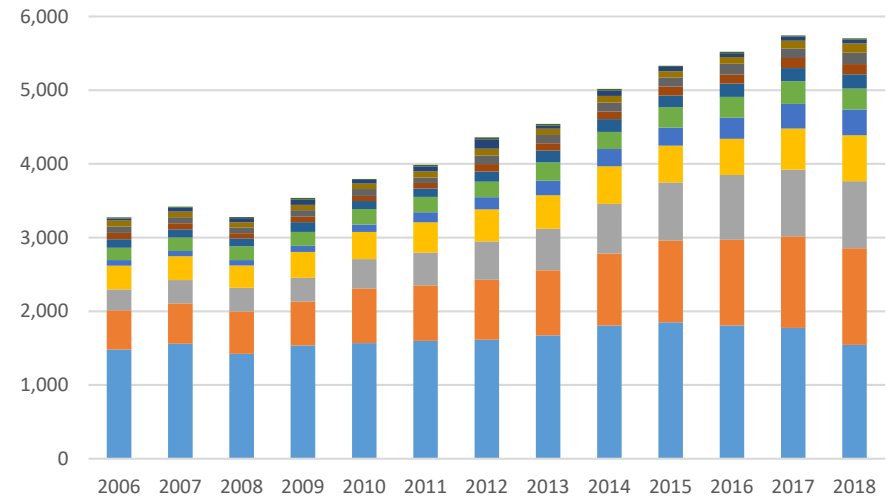
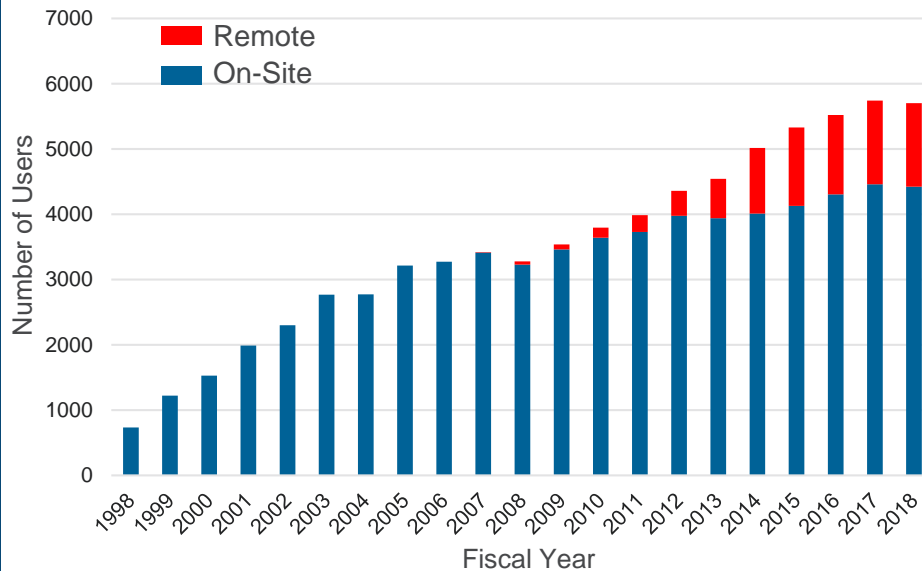

In FY2018:

- >5,700 unique onsite/offsite users from >700 institutions
- The APS accounted for approximately half of all DOE/BES light source users and one-third of all DOE/BES facility users

- Purchase of specialty services or materials
- Optics
- Other
- Medical applications
- Instrumentation or technique development
- Polymers
- Environmental sciences
- Earth sciences
- Engineering
- Physics
- Chemistry

High energy: Necessary to probe deeply into real materials in realistic environments

High-energy x-rays enable deep penetration, making it possible to probe:

- Samples behind thick-walled chambers of reaction vessels
- Buried structures in real materials
 - Turbine blades, commercial batteries
- Materials in extreme conditions, including high pressure, high temperatures

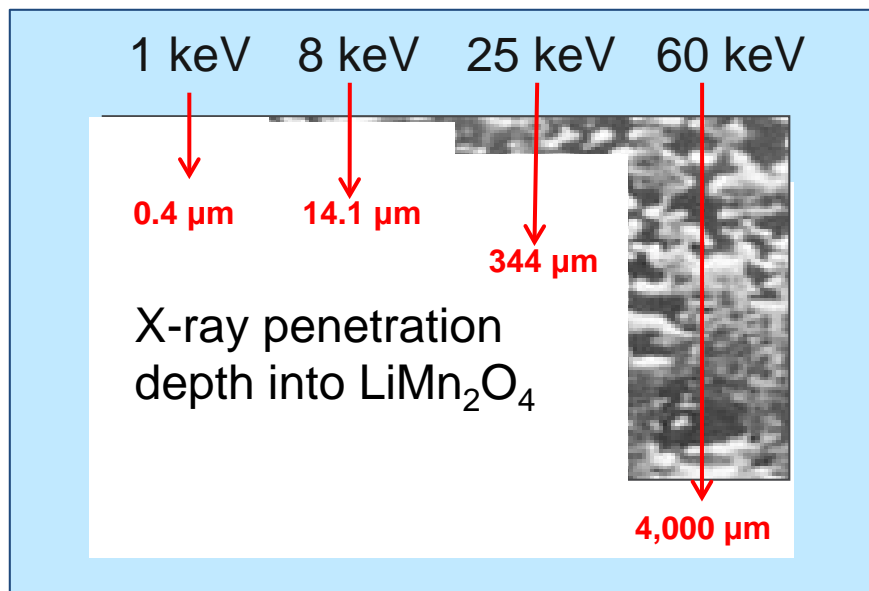

Coherent x-ray studies: Game-changing leap from average to local time/space information

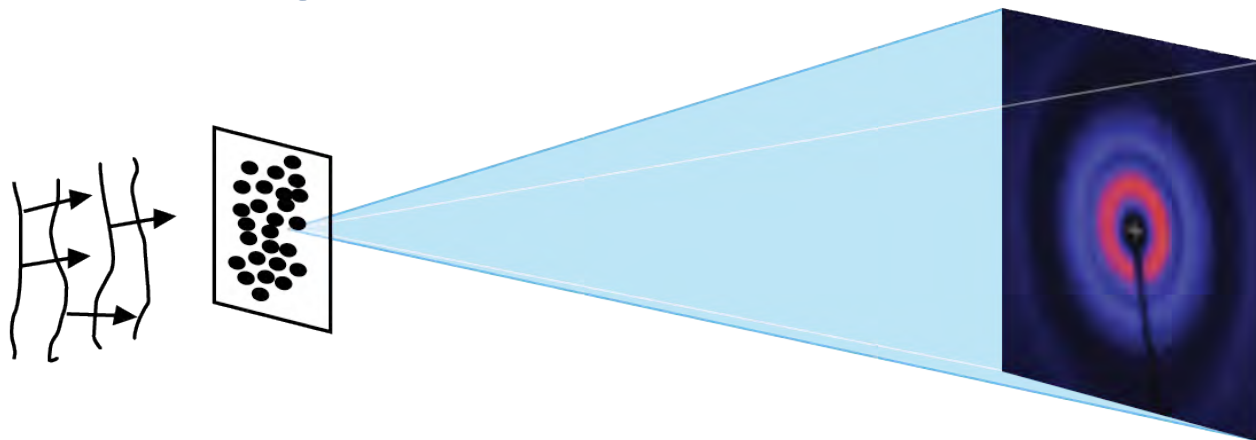

Incoherent beam carries average information; resolution limited by optics

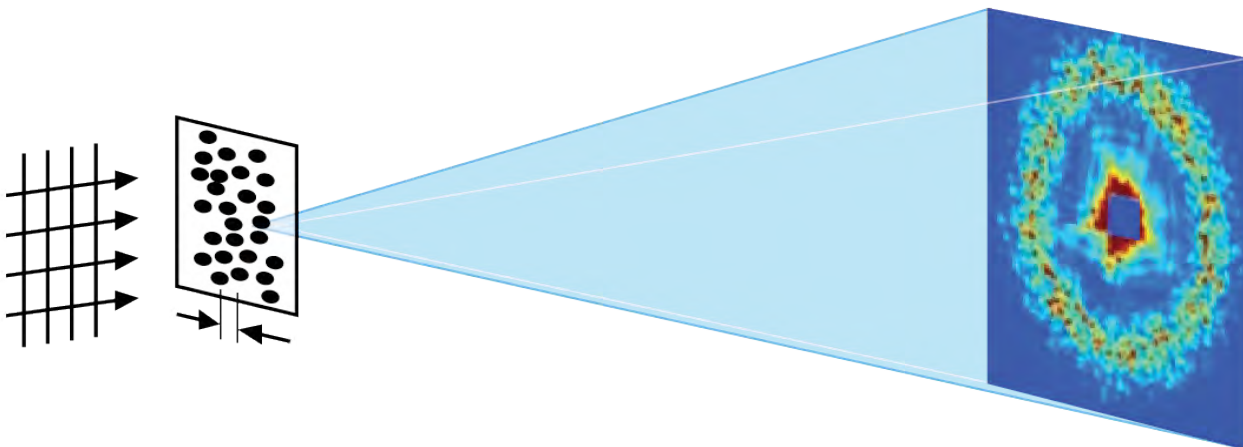

Scattering of coherent beam carries all microscopic, local information – non-periodic arrangements, correlations, dynamics

Spatial resolution limited only by x-ray wavelength, coherent flux

The Advanced Photon Source: The Hard X-Ray 3D Microscope

High Energy

Penetrating bulk materials and operating systems

- U.S.' brightest source of hard X-rays
- 3D mapping, deep inside samples
- X-ray cinematography

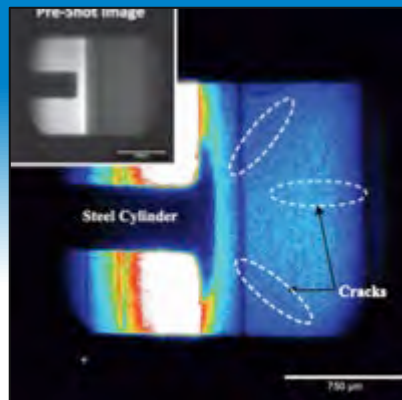

Brightness

Providing large fields of view with high resolution

- Multi-scale imaging – connecting microscale features across macroscopic dimensions
- Fast sampling with chemical, magnetic, electronic sensitivity

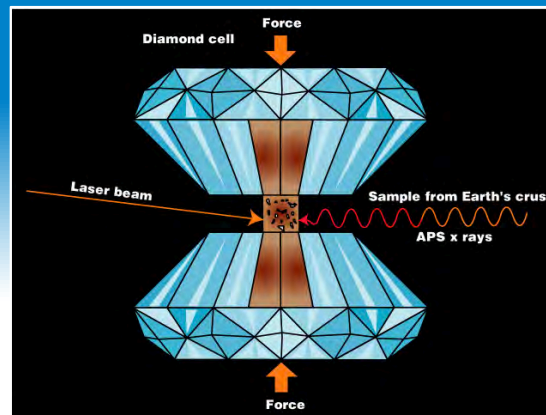

Coherence

Enabling highest spatial resolution even in non-periodic materials

- Extends lensless imaging with resolution down to 10 nm
- Correlation spectroscopy methods allow time resolution down to microseconds

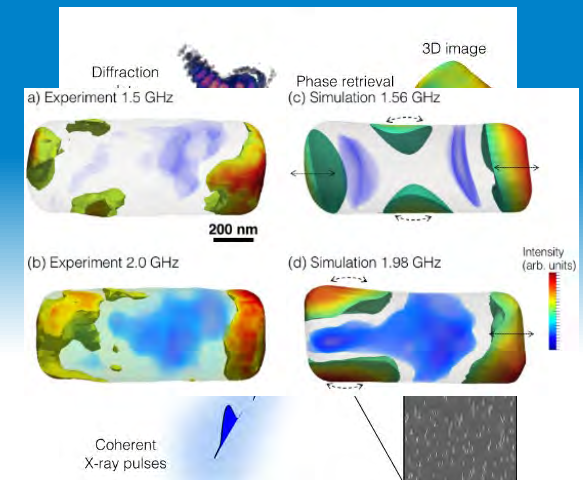

APS research: Significant impacts in science, industry

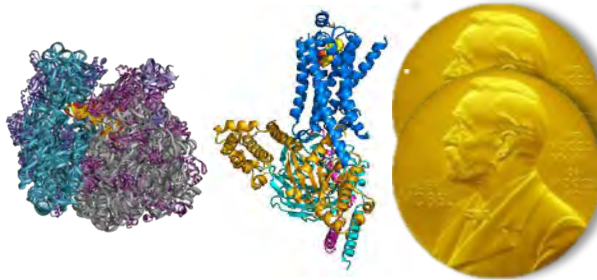

Nobel Prizes in Chemistry, 2009 (structure of ribosome) and 2012 (GPCRs)

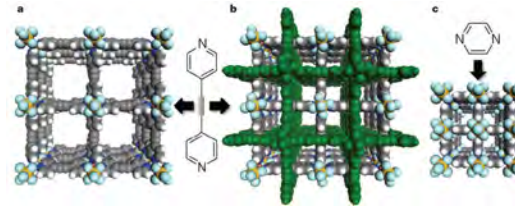

Reticular chemistry: CO₂ separation

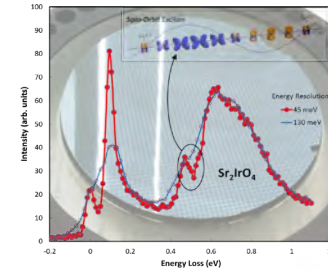

Magnon physics, quantum phase transitions, anti-ferromagnetic domain dynamics

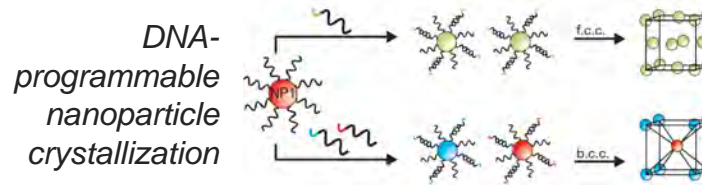

DNA-programmable nanoparticle crystallization

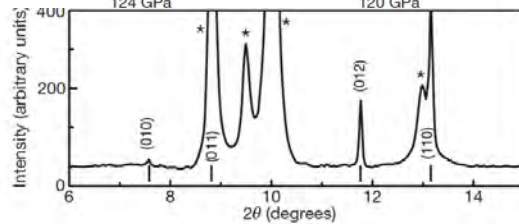
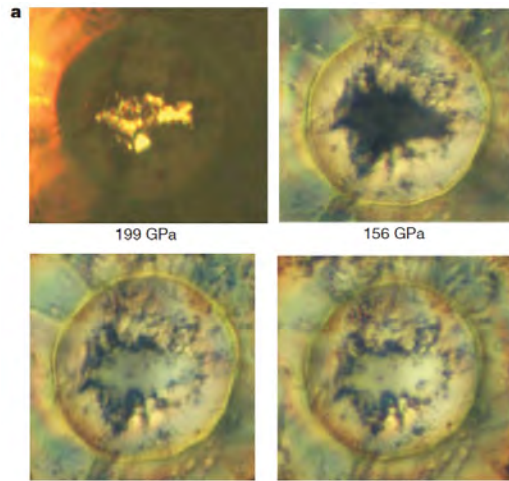
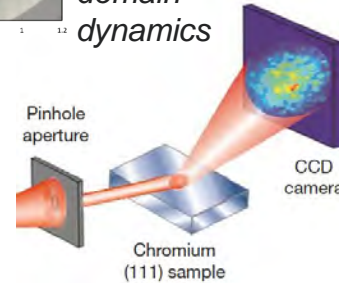

Equations of state under pressure: transparent dense sodium

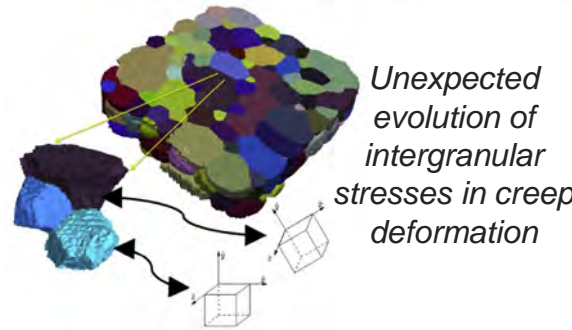

Unexpected evolution of intergranular stresses in creep deformation



Role of Zn in fertilization

Industrial impacts

- Drug development: Januvia (diabetes, Merck), Kaletra (HIV, AbbVie), Votrient (kidney cancer, GlaxoSmithKline), Zelboraf (melanoma, Genentech), Venclexta (leukemia, AbbVie)
- Cummins: fuel injectors
- Dow: solar shingles
- Chevron: improved catalysts for recovery of oil, natural gas
- DuPont: Suva™ refrigerants
- Chevrolet: batteries

abbvie

FDA approves new drug for treating leukemia.

VENCLEXTA

FDA Approves in April 2016

AbbVie developed important new drug, Venclaxta® (venetoclax) for treating leukemia

- First FDA-approved drug that targets B-cell lymphoma 2 (BCL-2) protein
- FDA granted
 - ‘breakthrough therapy’ designation
 - priority review
 - accelerated approval
- For treatment of patients with chronic lymphocytic leukemia (CLL) who have a chromosomal abnormality called 17p deletion (lack of protein p53 that suppresses cancer growth)
- Pipeline was 20 years
- X-ray crystallography was critical
- AbbVie is member of IMCA
- Proprietary research was conducted @ IMCA-CAT beamline 17-ID



EXAMPLE: SHIFTING THE METAL ADDITIVE MANUFACTURING R&D PARADIGM

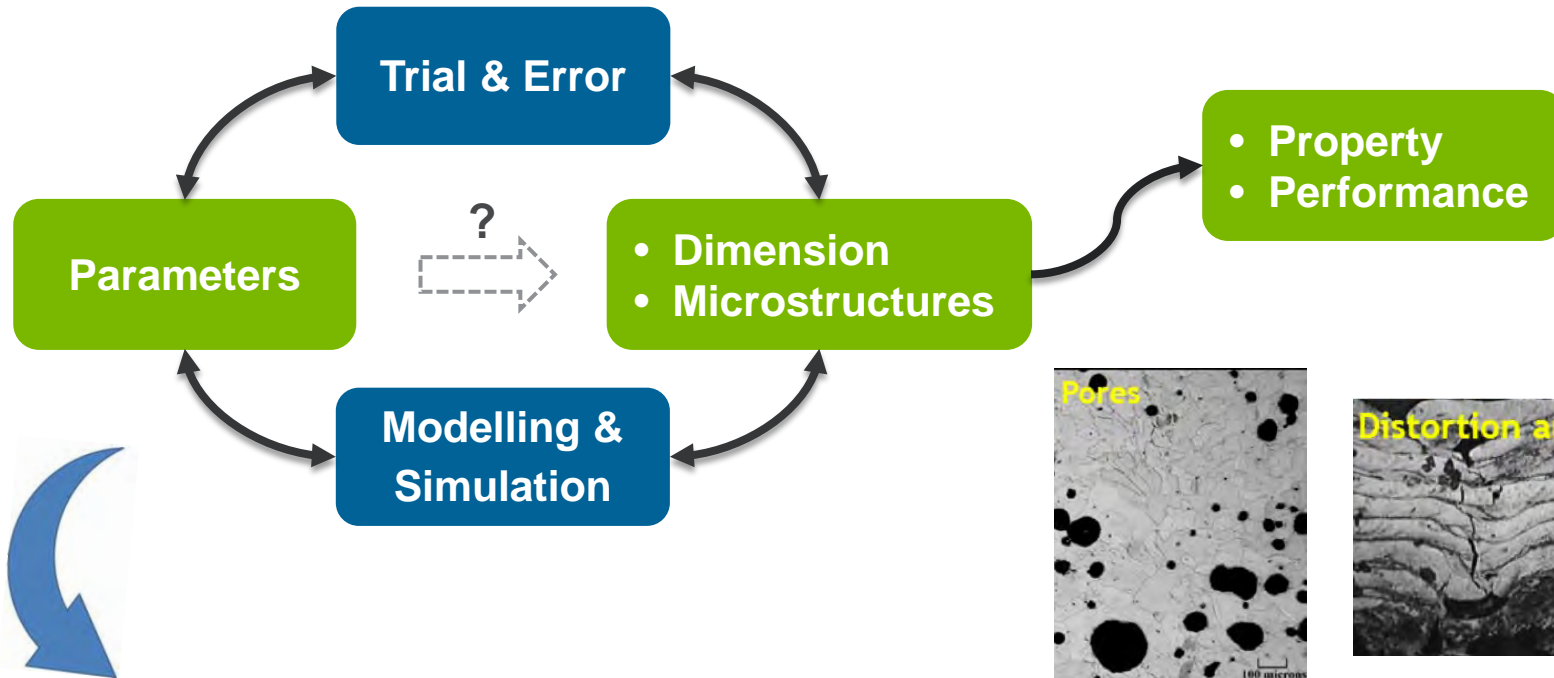

D. Gu, et al., International Materials Reviews, 57, (2012) 133

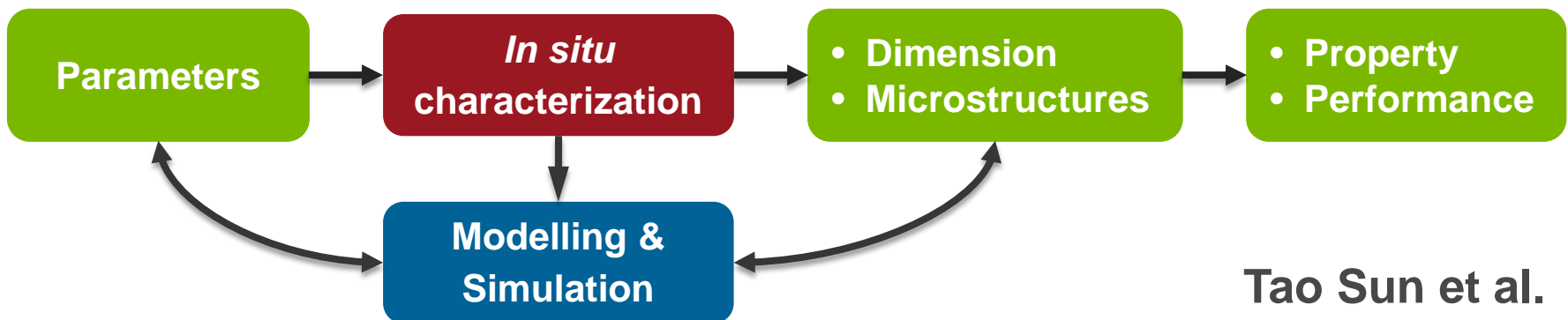

Tao Sun et al.

HIGH-SPEED X-RAY IMAGING

Laser powder bed fusion process (selected laser sintering)

Conduction melting mode

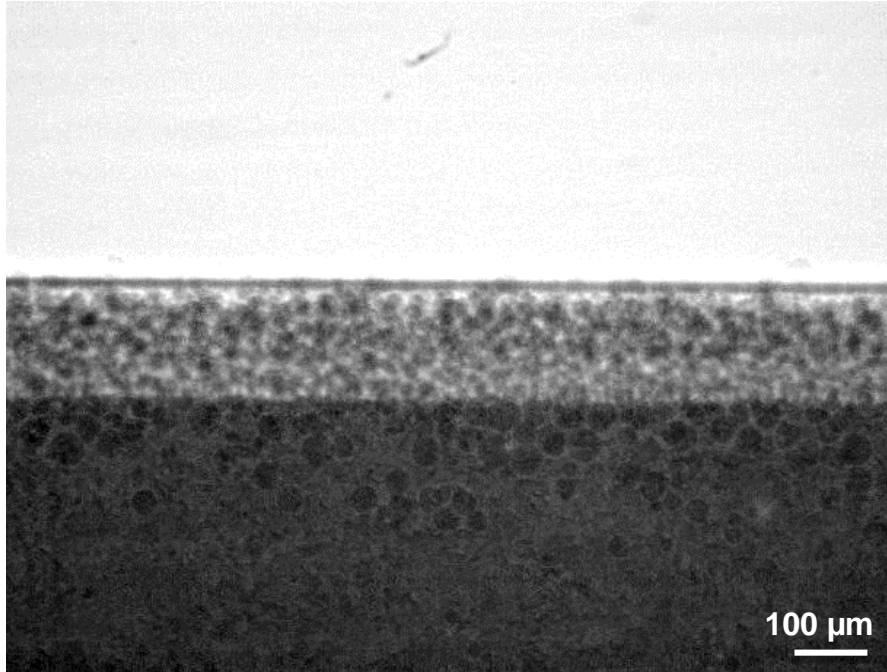

Frame rate: 45 kHz
Exposure: 100 ps
Laser power: **150 W**
Scan speed: 0.3 m/s
Laser spot: ~100 μm

“Keyhole” melting mode

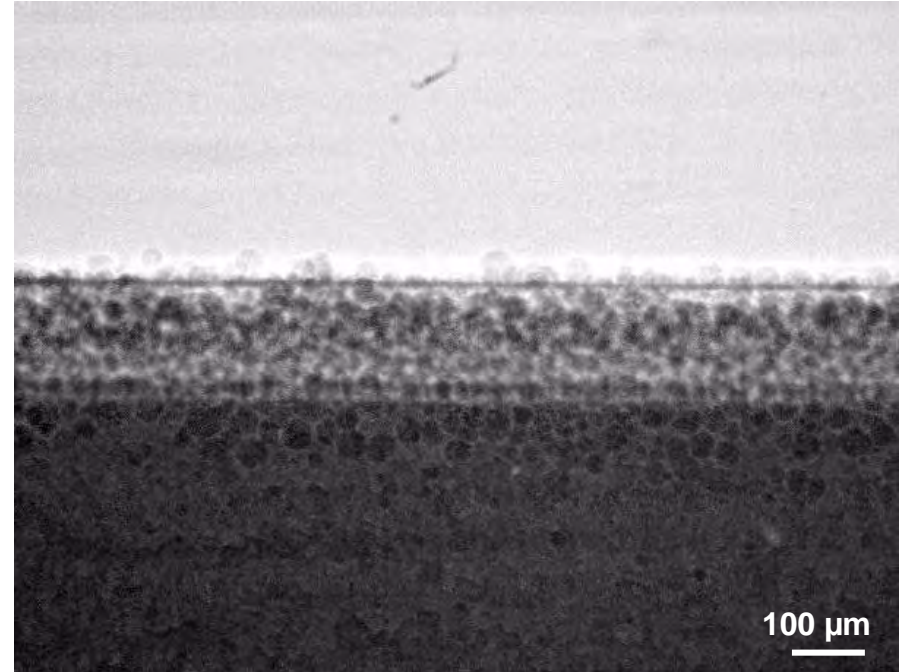

Frame rate: 45 kHz
Exposure: 100 ps
Laser power: **300 W**
Scan speed: 0.3 m/s
Laser spot: ~100 μm

COMING IN 2023*: THE APS UPGRADE

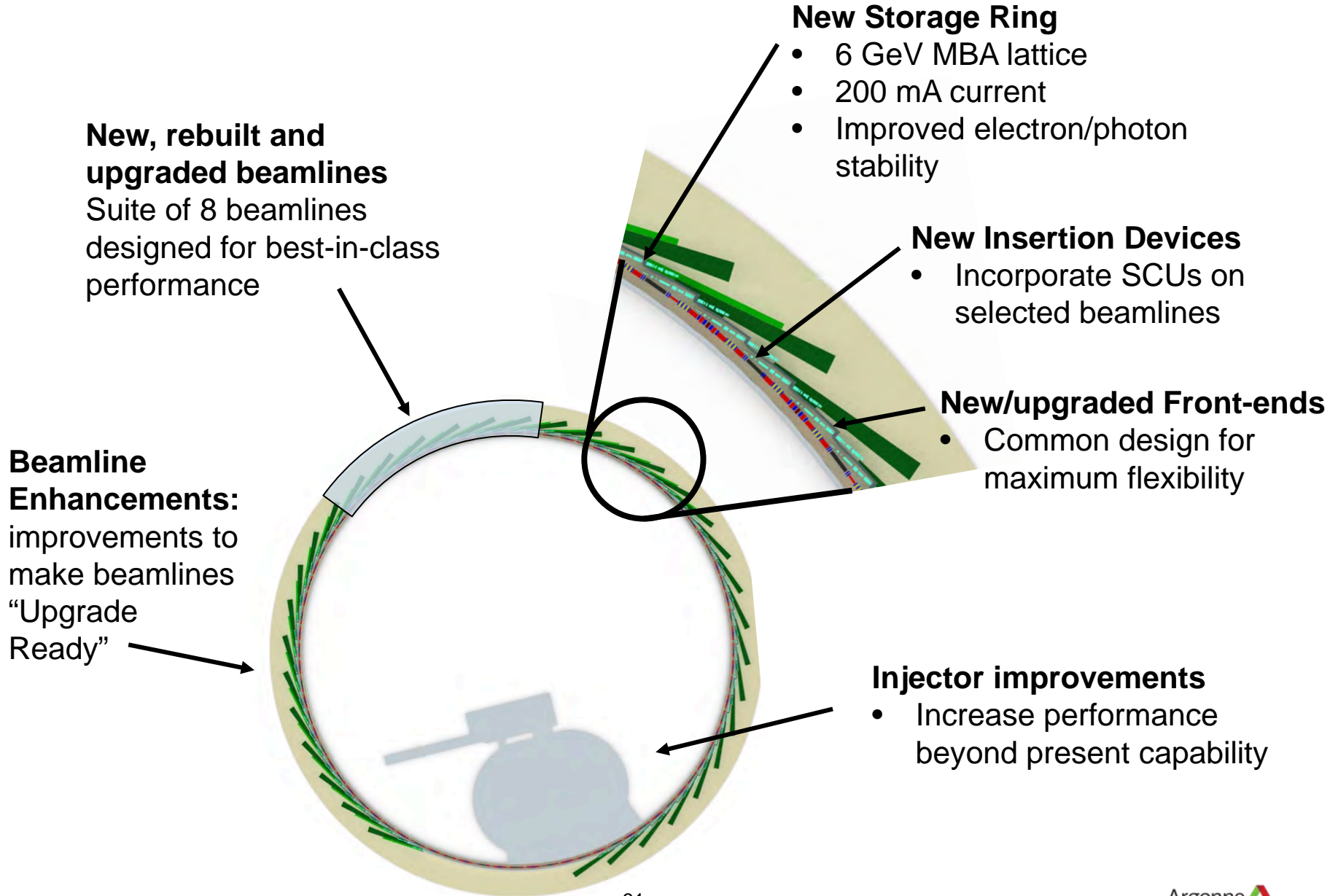

Coming in 2023* – The APS Upgrade:

The world's leading high-brightness hard x-ray storage ring

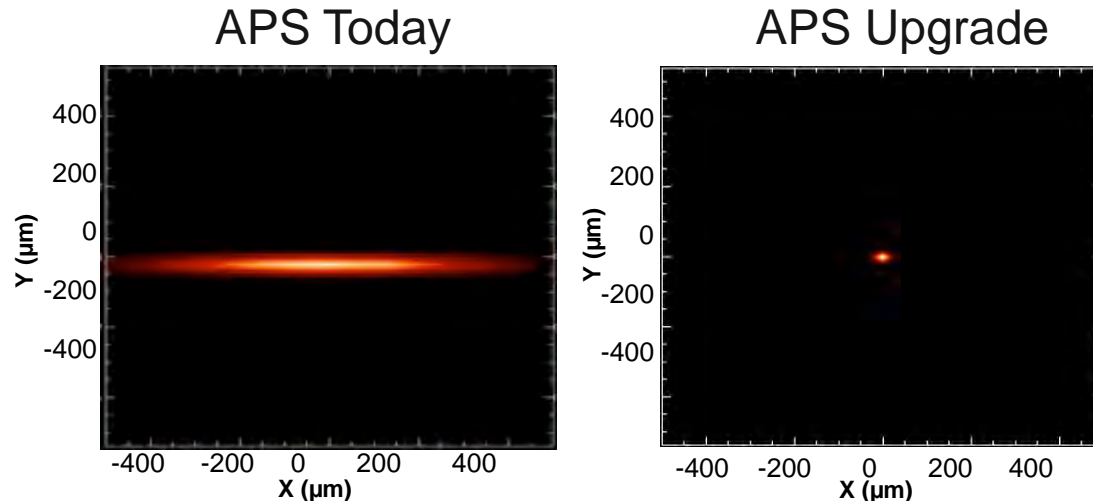

APS Upgrade will exceed the capabilities of today's synchrotrons by **2 to 3 orders of magnitude** in brightness, coherent flux, and nanofocused flux

World's brightest storage ring light source above 4 keV



Thanks!

Monochromators for Wavelength Selection

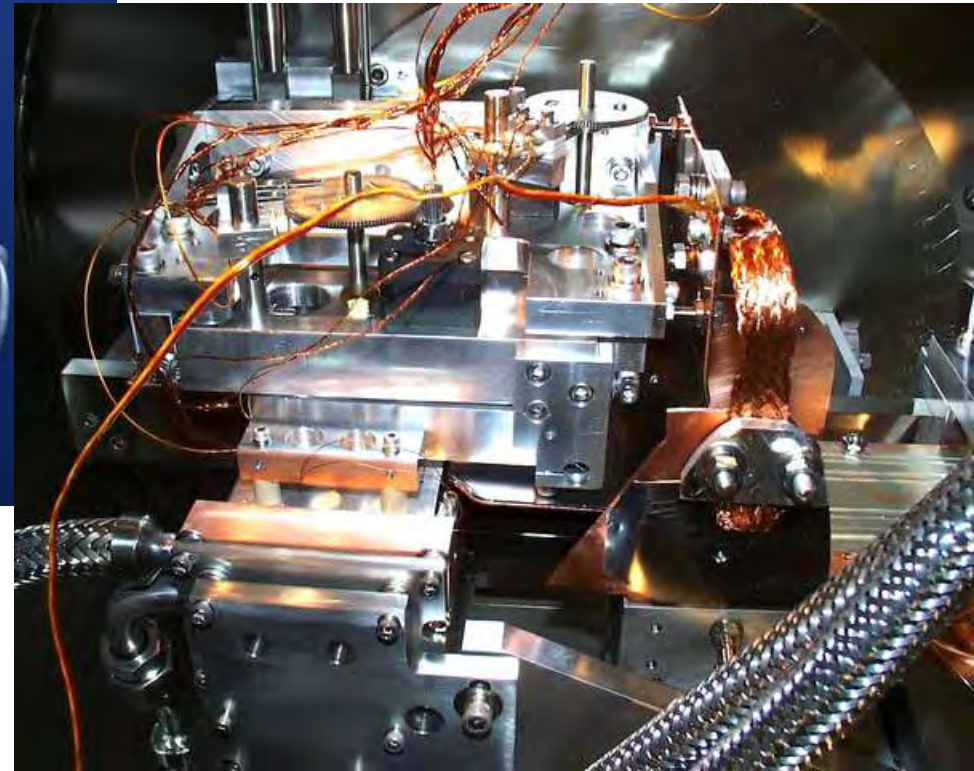

Monochromator used to select x-ray energy

In vacuum and LN₂ cooled

Important to align monochromator (angle) and undulator (gap) energy

Collaborative Assess Teams (CATs) at the APS

- CATs are made up of teams of researchers who have raised funds to build and operate a beamline or sector at the APS.
- CATs provide at least 25% of time to General Users through competitive process.
- Some CATs are funded as “National User Facilities” (NUFs) where all beam time is provided to their community (no set-aside time for member institutions or staff).
- Two CATs at APS are supported by NNSA:
 - High Pressure CAT
 - The Dynamic Compression Sector
- Sector 5 – DuPont-Northwestern-Dow (DND) CAT
- Sector 10 – Materials Research (MR) CAT
- Sector 13 – GeoSoilEnviro (GSE) CARS
- Sector 14 – BioCARS*
- Sector 15 – ChemMatCARS
- **Sector 16 – High Pressure (HP) CAT**
- Sector 17 – Industrial Macromolecular Crystallography Association (IMCA) CAT
- Sector 18 – BioCAT
- Sector 19 – Structural Biology Center (SBC) CAT
- Sector 21 – Life Sciences (LS) CAT
- Sector 22 – South East Regional (SER) CAT
- Sector 23 – General Medicine/Cancer (GM/CA) CAT*
- Sector 24 – Northeastern (NE) CAT
- Sector 26 – Nanoprobe (CNM)*
- Sector 31 – Lilly Research Labs (LRL) CAT
- **Sector 35 – Dynamic Compression Sector in commissioning***

*operational involvement by APS

EXPERIMENT SETUP

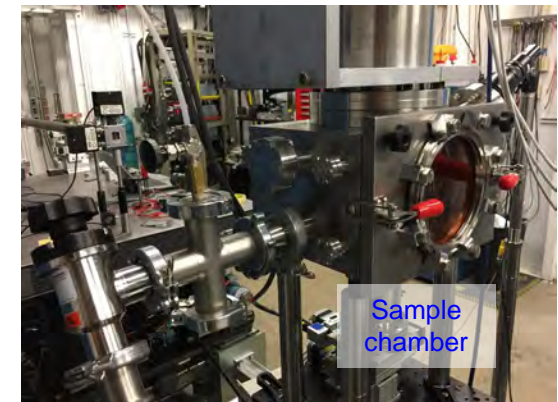
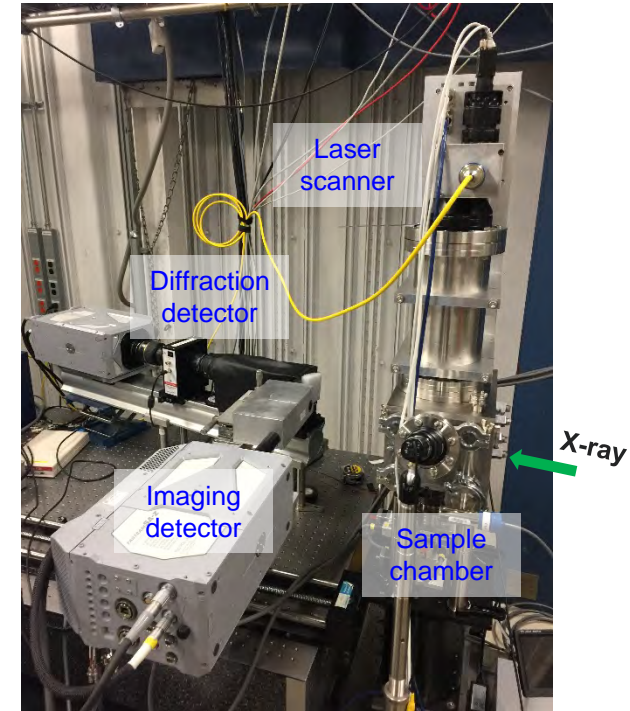
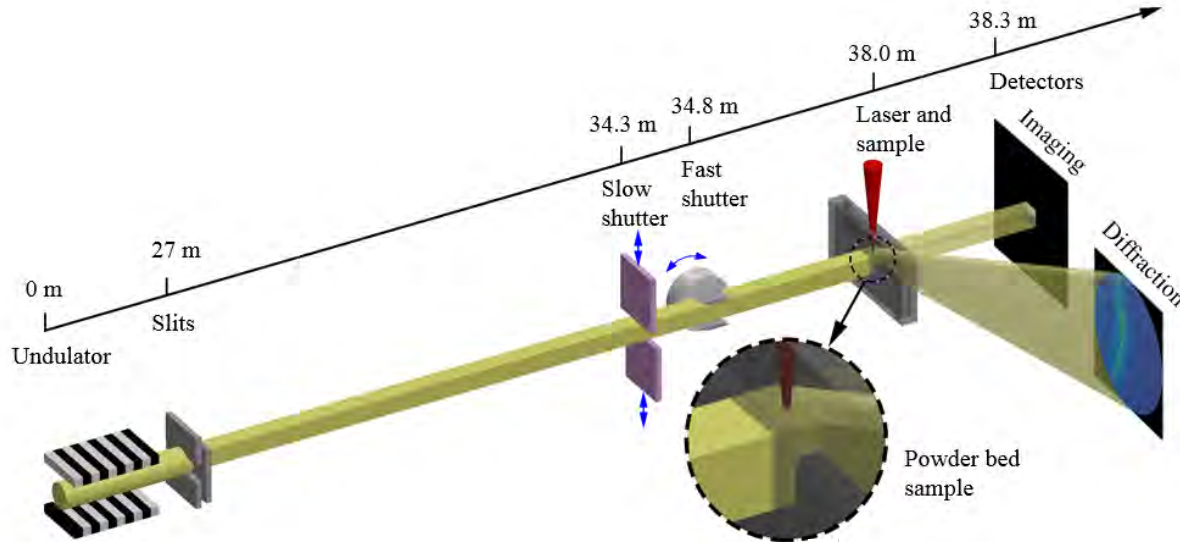

❑ Beamline

- 32-ID-B at APS
- Source: ~24 keV (4% bandwidth)
- Max spatial resolution: 1 μm
- Max temporal resolution: 100 ps

❑ Laser

- Ytterbium fiber
- Wavelength: 1070 nm
- Max power: 500 W
- Max scanning speed: 2 m/s

❑ Sample:

- Material: Ti-6Al-4V
- Thickness: 0.5 or 1 mm
- Protection gas: Ar
- Container: glassy carbon

UNIQUE CAPABILITIES OF HIGH-SPEED X-RAY TECHNIQUES

Melt pool dynamics

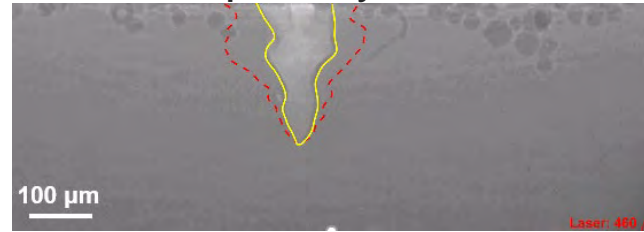

Phase transformation

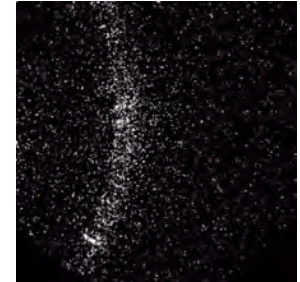

Powder spatter ejection

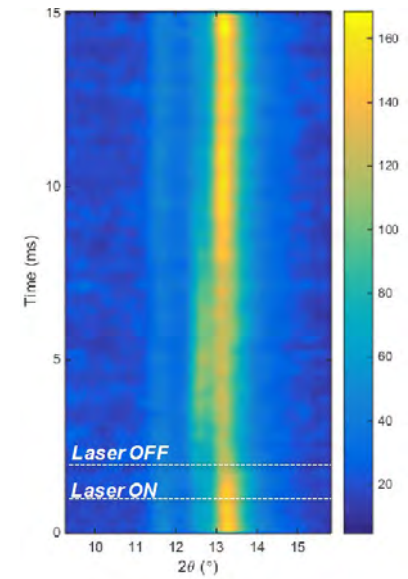
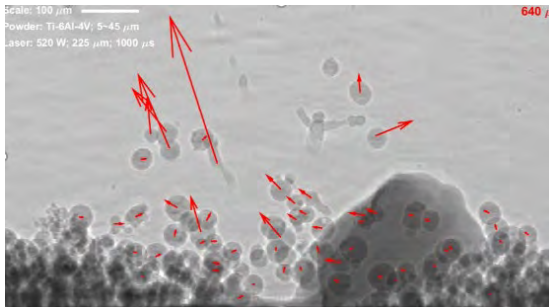

Rapid solidification

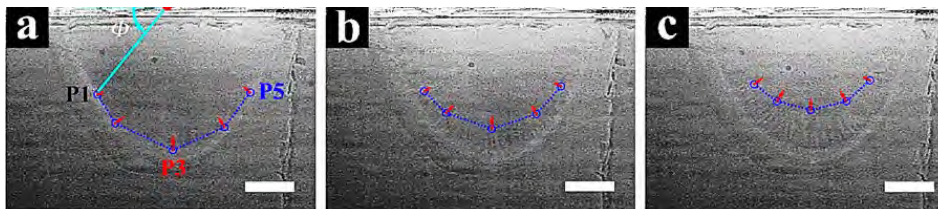

APS-U: Developing new, more durable structural materials

The Challenge

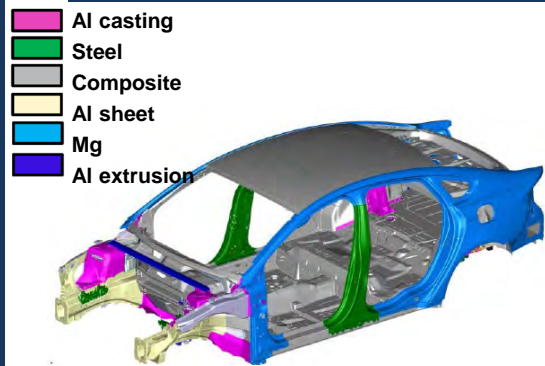

Global market for advanced materials (energy/environment)
\$90 billion yearly by 2020

- Deformation and failure of advanced materials are not sufficiently understood, leading to costly over-design
- Use of lightweight, advanced materials in 1/4 of U.S. vehicles could save more than 5 billion gallons of fuel annually by 2030
- 10% life extension of jet turbine engine disks = \$600K savings per aircraft

The Science Problem

Lack of predictive models validated by experiment prevents microstructure-sensitive design

- Information needed from subgrain level to macroscale
- Initial crack growth (a rare event) not understood, occurs at length scales not accessible today

State of the art today:
 1 μm 2D focus to study 30 μm grains

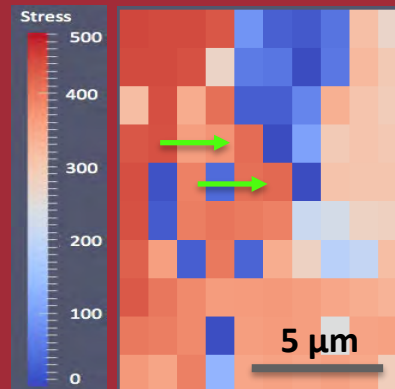

Simulation of deformation and crack formation in a superalloy; arrows show location of unresolved crack initiation

APS Upgrade

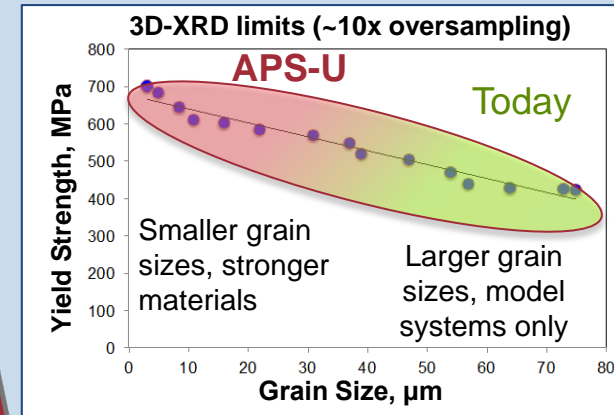

With APS-U:

- 80 keV brightness to penetrate bulk materials, measure strains with 50nm resolution

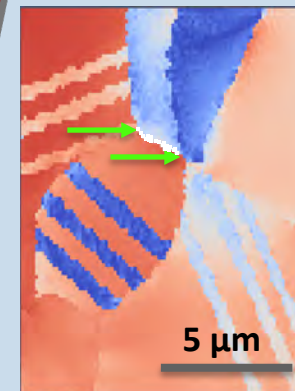

With APS-U, twin bands and initial crack are resolved

- Coherent imaging to measure intragrain & grain boundary properties